

*Radio-Television*

**SERVICE  
DEALER**

TV-AM-FM-RADIO-ELECTRONICS

FROM COLOR BAR GENERATOR

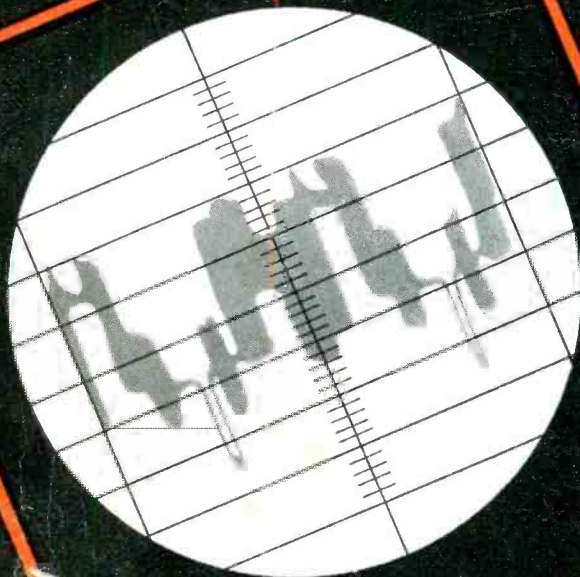
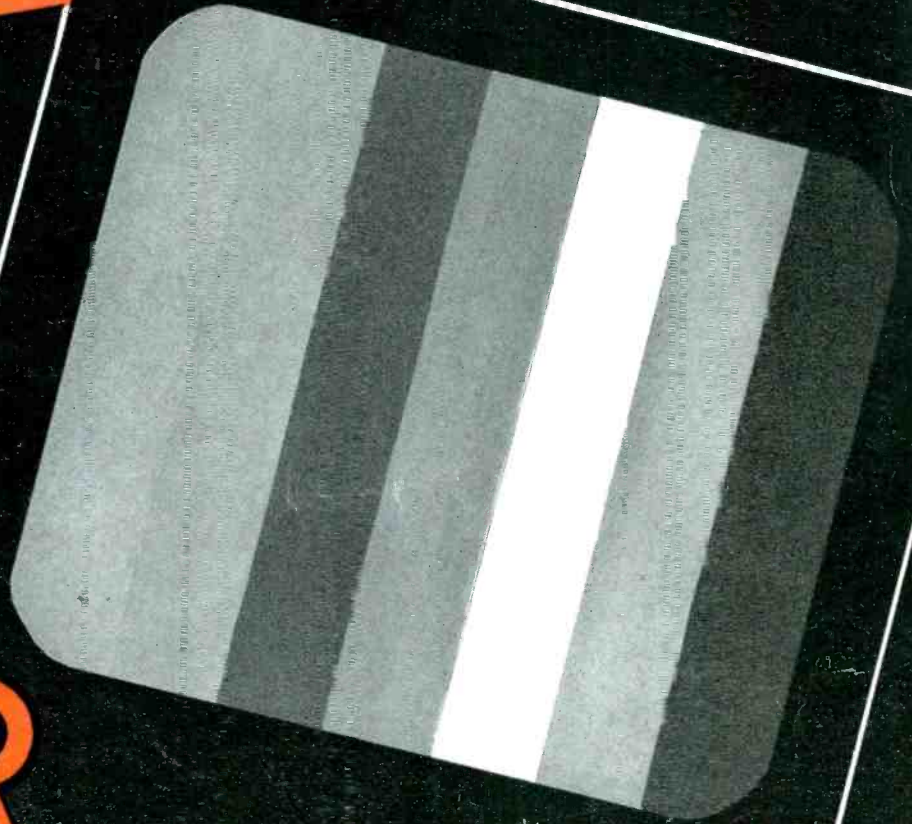

**COLOR TUBE PATTERN  
AND SCOPE WAVEFORMS  
OBTAINED USING COLOR**

INSURANCE MOTOR

JAN 56 14 48 284 14



# Preferred for modern set servicing

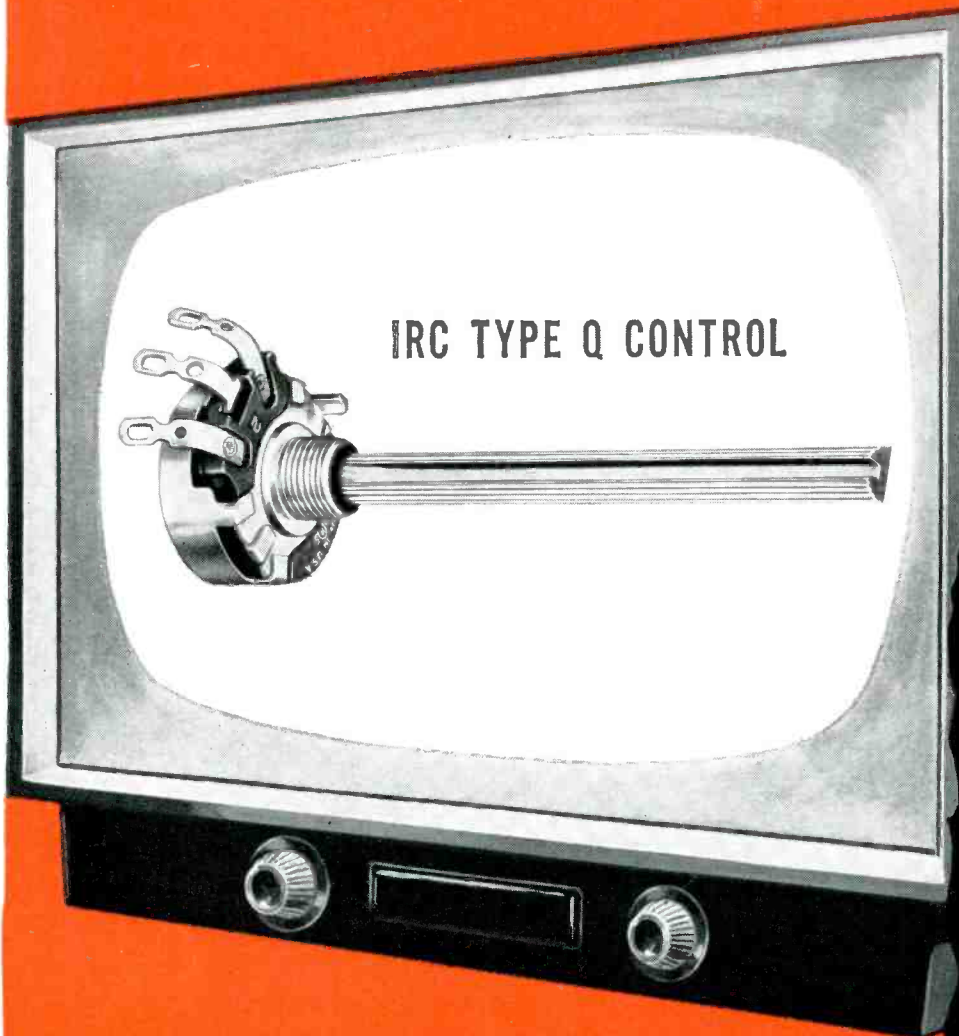

IRC TYPE Q CONTROL

Service technicians get greater coverage with less investment; more practical service features; and easier, faster installation with the IRC Type Q Control. Here's a dependable, basic control that is directly designed for modern set servicing. For appearance, performance and price . . . there's none better. So why settle for less? Tell your Distributor you want Q Controls . . . most servicemen do.



This 8 page catalog gives you all the facts . . . Send for your free copy now—

## INTERNATIONAL RESISTANCE CO.

Dept. 491, 401 N. Broad St., Phila. 8, Pa.

In Canada: International Resistance Co., Ltd., Toronto, licensee

Send me Q Control Catalog DC1D.

Name \_\_\_\_\_

Company \_\_\_\_\_

Address \_\_\_\_\_

City \_\_\_\_\_ State \_\_\_\_\_

### KNOBMASTER FIXED SHAFT

Q Control standard shaft is knurled, flatted and slotted—fits most knobs without alteration.

### INTERCHANGEABLE FIXED SHAFTS

Exclusive IRC convenience feature—provides fast conversion to "specials", with FIXED shaft security. 15 types available.

### 1/4" LONG BUSHING

Accommodates all small sets, yet handles large set needs perfectly.

### 7 STANDARD TAPERS

Full coverage of all taper requirements is provided in the Q Control.

### 94 RESISTANCE VALUES

For TV, AM and FM coverage, 94 values of plain and tapped controls are furnished.

### QUALITY APPEARANCE

The handsome professional appearance of IRC Q Controls lets you point to your work with pride.

### CUSHIONED TURN

The smooth, quality of "feel" of a Q Control contributes to customer confidence.

### TYPE 76 SWITCHES

Either of two type IRC switches attached as quickly and easily as a control cover—meets all your requirements.



Wherever the Circuit Says 

only

# C·D·R Rotors

have  
the

**1**

**2**

**punch**

## 1. The Most Complete Line

The CDR Rotor line is COMPLETE to every detail, with a model for every application! A distinct selling advantage because YOU can give your customer EXACTLY what is required! The RIGHT CDR Rotor for the RIGHT job.

## 2. Pre-SOLD For You on TV

to millions of viewers through an extensive coverage of audiences in every important TV market. Capture this pre-sold market by featuring these nationally advertised CDR ROTORS.

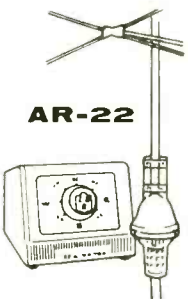
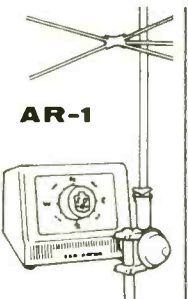
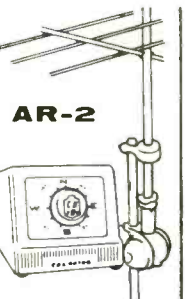
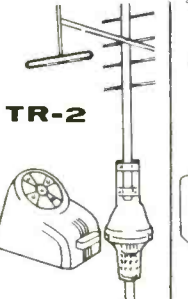
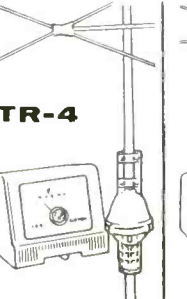
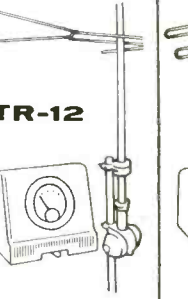
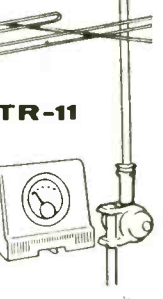
 <p><b>AR-22</b></p>	 <p><b>AR-1</b></p>	 <p><b>AR-2</b></p>	 <p><b>TR-2</b></p>	 <p><b>TR-4</b></p>	 <p><b>TR-12</b></p>	 <p><b>TR-11</b></p>
<p>Completely AUTOMATIC version of the TR-2 with all the powerful features that made it famous.</p>	<p>Completely AUTOMATIC rotor, powerful and dependable. Modern design cabinet. 4 wire cable.</p>	<p>Completely AUTOMATIC rotor with thrust bearing. Handsome cabinet. 4 wire cable.</p>	<p>Heavy-duty rotor with plastic cabinet. "compass control" illuminated perfect pattern dial, 8 wire cable.</p>	<p>Heavy-duty rotor, modern cabinet with METER control dial, 4 wire cable.</p>	<p>Combination valve complete rotor with thrust bearing. Modern cabinet with meter control dial, uses 4 wire cable.</p>	<p>Ideal budget all-purpose rotor, new modern cabinet featuring meter control dial, 4 wire cable.</p>



**CORNELL-DUBILIER**  
SOUTH PLAINFIELD, N. J.



**THE RADIART CORP.**  
CLEVELAND 13, OHIO



For ALUMINIZED TUBE PERFORMANCE, *plus* EXCELLENT TUBE LIFE . . . Replace with



Thanks to LUMILAC, Raytheon Aluminized Picture Tubes provide sharper pictures, high light output and superior contrast — *plus excellent tube life*. LUMILAC, — a lacquer especially blended and used exclusively by Raytheon — is the secret of superiority. This amazing lacquer produces an extra smooth, unbroken surface for the pure aluminum coating, yet leaves no gas-producing residues which could impair cathode emission and shorten tube life.

What's more, the quality of Raytheon Aluminized Picture Tubes is safeguarded by Raytheon's great ultra-modern Cathode Ray Tube Plant in Quincy, Mass. — a plant designed and built solely for the manufacture of first quality picture tubes.

Replace with Raytheon Aluminized Picture Tubes — they are best for you and your customers, too.

## RAYTHEON "Lumilac" ALUMINIZED PICTURE TUBE REPLACEMENT GUIDE

RAYTHEON "Lumilac" ALUMINIZED PICTURE TUBE	REPLACES STANDARD TYPE	NECESSARY ADJUSTMENTS OR CHANGES	RAYTHEON "Lumilac" ALUMINIZED PICTURE TUBE	REPLACES STANDARD TYPE	NECESSARY ADJUSTMENTS OR CHANGES
12KP4A	12KP4	None.	21AUP4A	21AUP4	None.
	12QP4	Ground conductive coating. Remove ion trap.		21AUP4B	None.
	12QP4A	Ground conductive coating. Remove ion trap.	21AVP4A	21AVP4	None.
	12RP4	Ground conductive coating. Remove ion trap.		21AVP4B	None.
16KP4A	16KP4	None.	21EP4B	21EP4	Ground conductive coating.
	16QP4	Ground conductive coating. Change ion trap.		21EP4A	None.
	16RP4	Check conductive coating contact.	21FP4C	21FP4	Ground conductive coating.
	16TP4	Space may not be sufficient in some cases.		21FP4A	None.
	16XP4	Ground conductive coating. Change ion trap.		21YP4A	21AFP4
17BP4B	17BP4	Ground conductive coating.	21YP4		None.
	17BP4A	None.	21ZP4B	21ZP4	Ground conductive coating.
	17BP4C	None.		21ZP4A	None.
	17JP4	Do not exceed voltage rating.	24CP4A	24CP4	None.
17HP4B	17HP4	None.		24QP4	None.
	17HP4A	None.		24TP4	None.
	17RP4	None.		24XP4	Ground conductive coating.
17LP4A	17LP4	None.	24DP4A	24DP4	None.
	17VP4	None.		27EP4	27GP4
20DP4C	20DP4A	None.	27NP4		Add filter condenser.
21ALP4A	21ALP4	None.	27RP4	27GP4	Ground conductive coating.
	21ALP4B	None.		27NP4	None.
	21ANP4	Ground conductive coating.			
	21ANP4A	Ground conductive coating.			



**RAYTHEON MANUFACTURING COMPANY**  
 Receiving and Cathode Ray Tube Operations  
 Newton, Mass. • Chicago • Atlanta, Ga. • Los Angeles, Calif.

Raytheon makes all these { Receiving and Picture Tubes, Reliable Subminiature and Miniature Tubes, Semiconductor Diodes, Power Rectifiers and Transistors, Nucleonic Tubes, Microwave Tubes



Excellence in Electronics



# EVERY SERVICE FIRM OWNER IN THE U.S.A. Receives SERVICE DEALER Monthly

Member **EPA** — Circulation Statement sent on request

**COWAN PUBLISHING CORP., 67 West 44th Street, New York 36, N. Y.**

Telephone MURRAY Hill 7-2080

VOL. 17, NO. 1

JANUARY, 1956

## EDITORIAL STAFF

*Publisher*  
**SANFORD R. COWAN**

*Editor*  
**SAMUEL L. MARSHALL**

*Editorial Production*  
**ROBERT CAMPBELL**

*Contributing Editors*  
**ROBERT T. DARGAN**  
**PAUL GOLDBERG**  
**OSCAR FISCH**  
**SAN D'ARCY**

*Cover by*  
**MIKE LOYER**

## BUSINESS STAFF

*Advertising Department*  
**RICHARD A. COWAN**  
**JACK N. SCHNEIDER**  
**JAMES STILLMAN**

*Production Manager*  
**DAVID SALTMAN**

*Circulation Manager*  
**HAROLD WEISNER**

*Ass't Circ. Mgr.*  
**C. J. BINDERMAN**

## BRANCH ADVERTISING OFFICES

West Coast:—**TED E. SCHELL**, 2700 W Third St., Los Angeles, Calif. DU nKirk 2-4889

Mid-West:—**JIM SUMMERS**, 400 N. Michigan Ave., Chicago 11, Ill. SU perior 7-1641

## FEATURE ARTICLES

<b>New FM Tuners, part 1</b> , by Steve Travis .....	10
A discussion of tuner terminology and operating characteristics	
<b>Zenith Flash-Matic Remote Control</b> , by Oscar Fisch .....	20
Simplified explanation of its operation and service	
<b>Color Sync Analysis, part 2</b> , by Bob Dargan and Sam Marshall .....	24
Discussion of burst gate operation in color TV receivers	
<b>Unusual Tube Trouble, Sound Bars in Pix, Insufficient Vertical Sweep</b> , (A Work Bench Feature) by Paul Goldberg .....	27
<b>The Dyna-Quick Tube Tester</b> , by The Engineering Dept., B&K Mfg. Co. ....	28
A tester designed for rapid and effective tube checking	
<b>Probemeter</b> , by Engineering Staff, Research Inventions & Mfg. Co. ....	31
A device with some unusual service applications	
<b>Radio-TV Service Dealer Complete Manufacturers Schematics</b> .....	49-56
Complete Preliminary Service Data on Zenith "X" Series, Chassis 16X20, 17X20, -22; 19X21, -22, -24; 22X20, -21, & 22.	

## CIRCUIT AND SERVICE FORUM

<b>The Answer Man</b>	
Shorted 6AM8 .....	19
Magnavox CTA404B .....	19
Troubleshooting printed panel chassis .....	40
Motorola TS531: Sync Buzz .....	41
Checking new tube types .....	41
<b>The Work Bench</b>	
Admiral 22A2: Unusual tube trouble .....	27
GE21T7: Sound bars in pix .....	27
Du Mont RAI05: Insufficient vertical sweep .....	43
<b>Video Speed Servicing Systems</b>	
Emerson chassis 120220-D, 120239D, F .....	33

## DEPARTMENTS

Editorial .....	4	Answer Man .....	19
Trade Flashes .....	6	Work Bench .....	27
Rider Speaks .....	14	New Components .....	32
Association News .....	16	Advertising Index .....	48
<b>Complete Manufacturer's Schematics</b> .....		49	

Our front cover this month illustrates a color bar pattern appearing on a CBS-Columbia 205TV Receiver. The signal for this pattern was generated by a Hickock 655XC Color Bar Generator. The scope used was a Hickock Model 770.

RADIO-TELEVISION SERVICE DEALER is published monthly by Cowan Pub. Corp., 67 West 44th St., New York 36, N. Y. Subscription price: \$1.00 per year in the United States, & U.S. Poss. Elsewhere \$1 per year additional. Single Copies 25c. Second Class mail privileges authorized at New York, N. Y. Copyright 1956, Cowan Publishing Corp. Tel.: MU 7-2080.

POSTMASTER: SEND FORM 3579 TO RADIO-TELEVISION SERVICE DEALER, 67 WEST 44TH ST., NEW YORK 36, N. Y.





# EDITORIAL... by S. R. COWAN PUBLISHER

## Your Cooperation Will Help

Brand Name Surveys of Chicago is about to conduct a nation-wide survey of brand preferences among radio and TV servicemen. In February questionnaires will be mailed to servicemen throughout the United States. Servicemen will be asked why they prefer certain brands of electronic replacement components. The answers, when collated, will be used by the manufacturers who are participating in the survey as a means of improving their products and making them easier for servicemen to use.

All servicemen should take the few moments necessary to answer the impending Brand Name and other such surveys that come along. Surveys serve a useful purpose, not only for those seeking information, but also for those who reply. For example, our circulation manager periodically surveys all our 73,000 readers asking them pertinent questions about their work. The replies help us maintain accurate circulation records, the facts given are kept in confidence, but in addition they guide our editors in selecting articles that will be of optimum value to our subscribers. Incidentally many subscribers inquire "what does BPA mean?" BPA means Business Publications Audit—an organization that verifies and then audits the circulation records and claims of magazines like SERVICE DEALER.

## Dealers Down — Servicemen Up

Our records indicated that during the past twelve months upwards of 3100 radio-TV service dealers discontinued selling TV set lines and became service firms exclusively so they could concentrate on the more profitable part of their business, servicing, and get out of the rat-race, competitive selling field. This is particularly true in big cities and their closely adjacent suburbs. Discount houses scrapping price-wise with department stores have cut out of competition many neighborhood retail stores.

In addition, many service dealers report to us that although they have discontinued selling TV set lines they have instead reinvested that money in lines of Hi-Fi equipment—and without a pun intended—it's a sound switch. Hi-Fi is selling nicely. In 1955 Hi-Fi sales passed the \$100 million mark.

A small service dealer who carried a \$3000 stock of TV sets, before the discount house era, expected

to realize a 3 time-a-year turnover with an approximate net profit of \$900. Since discount houses and department stores have been price-fighting these same service dealers have operated in the red. Now, by investing the same sum in Hi-Fi, and by going after the vast amount of Public Address sales, service and rental business available, the service dealers are realizing a better turnover and upwards of \$1300 net profit per annum.

## Stormy Weather Ups Antenna Sales

Careful analysis of TV antenna sales over a period of several years shows that normally most antennas are sold between January and May. There has usually been a fall off from June to September—and then after a big October—another dip until January.

1954 and 1955 were exceptions. Freak hurricanes, torrential floods and heavy snow-falls in various parts of the country upset the former pattern. For example, the rains and floods that hit the east coast in mid-summer of 1954 and again in 1955 destroyed more antennas (requiring the immediate installation of new ones) than normal weather and deterioration would have in 2 years.

## Transistors Won't Replace Tubes For Years

Noting the vast number of transistorized radios being marketed of late, and realizing that all servicemen derive a substantial profit monthly from replacement tube sales—I began to wonder, as did many servicemen, whether or not in the days ahead we might find ourselves transistorized out of tube replacement sales. Putting the question straight-forwardly to the transistor makers—we learned that they believe that transistors won't seriously affect a serviceman's profits from tube sales for at least 20 to 30 years to come.

Today there are less than  $\frac{3}{4}$  million transistor-operated radios and used (with a total of 3 million transistors in use) compared to over 1.6 billion tubes in home and auto radios and TV sets—and not including the other billions of tubes being used daily in the myriad of other electronic applications.

The mathematical progression is such that with every passing month servicemen can logically expect to sell over 1% more replacement electronic tubes than the preceding month—because every year there are 15% more tube sockets in use than there were in the corresponding previous year. In other words—things look good for tube makers—and we who sell 'em as replacements.

# The unfailing Dependability of BUSS FUSES . . .

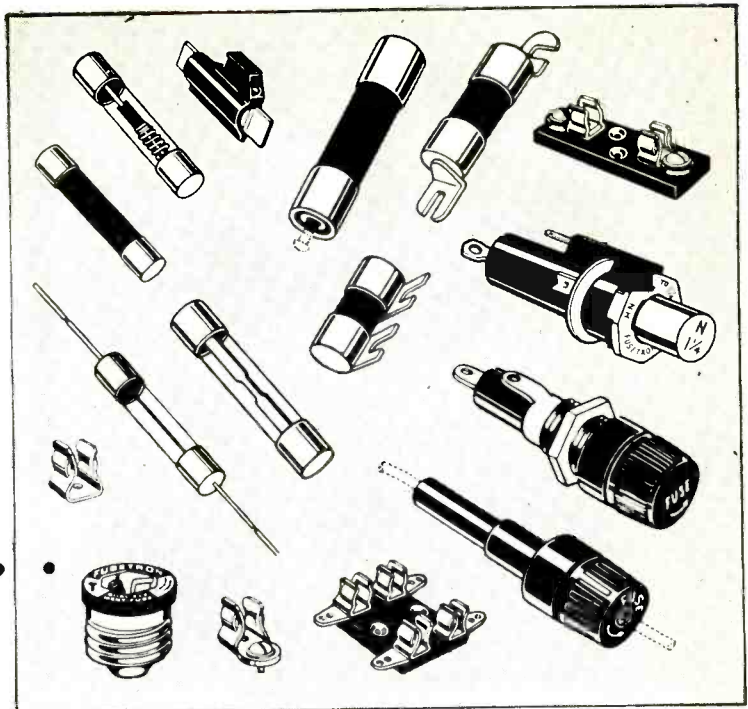

## helps you keep customers satisfied!

By operating properly under all service conditions — BUSS fuses can help safeguard the reputation of your product or service against loss of customer good will.

When there is an electrical fault — BUSS fuses open and prevent further damage to equipment, saving users the expense of replacing needlessly burned out parts.

And just as important, BUSS fuses won't give a false alarm by blowing when trouble doesn't exist. Useless shutdowns caused by poor quality fuses blowing needlessly are not only irritating to customers — but customers' confidence in your product or service could be jolted.

**Every BUSS fuse is electronically tested to assure "trouble-free" operation.**

Every BUSS fuse normally used by the Electronic Industries is electronically tested. A

sensitive device automatically rejects any fuse not correctly calibrated, properly constructed and right in all physical dimensions.

With a complete line of fuses, fuseholders and fuse blocks available — it is just good business to standardize on BUSS.

For more information on FUSETRON and BUSS small dimension fuses and fuseholders . . . Write for bulletin SFB.

*Makers of a complete line of fuses for home, farm, commercial, electronic, automotive and industrial use.*



**BUSSMANN MFG. CO.**  
(Division of McGraw Electric Co.)  
UNIVERSITY AT JEFFERSON  
ST. LOUIS 7, MO.

156

**BUSS FUSES ARE MADE TO PROTECT  
— NOT TO BLOW**



"MAN, OUR SET  
SURE WORKS SWELL NOW!"

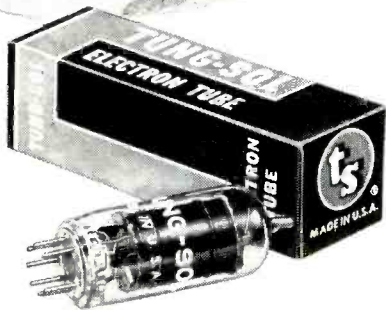

"Boy, was I sunk when our set went off the night before the All-Star game! But our repairman fixed it with a Tung-Sol Tube in the morning and it's been in World Series form ever since. Our repairman's a real pro."

## **TUNG-SOL<sup>®</sup>** dependable **TUBES—DIAL LAMPS**

TUNG-SOL makes All-Glass Sealed Beam Lamps, Miniature Lamps, Signal Flashers, Picture Tubes, Radio, TV and Special Purpose Electron Tubes and Semiconductor Products.

# trade

The outlook for the radio-television and electronics industry is more encouraging now than the 1955 outlook had been at this time last year, James D. Secrest, executive vice president of the Radio-Electronics-Television Manufacturers Association, reported during a Symposium on the Business Outlook for 1956 sponsored by the U. S. Chamber of Commerce in Washington. He expressed the belief of many industry leaders that at least 250,000 color sets will be sold next year but pointed out that the governing factor will be the number and quality of color broadcasts, over which the manufacturers have no direct control. If other new records are not set in 1956 it will not be surprising, Mr. Secrest pointed out, considering that factory sales of all electronics products rose to a new peak of about \$5.5 billion this year, nearly 10 percent above 1954; TV receiver production and sales are at the highest point on record; radio production will exceed 14 million sets compared with 10.4 million last year, and military electronic procurement and deliveries increased to about \$2.4 billion despite a general cutback in defense spending.

The television industry should sell 300,000 color sets in 1956. H. Leslie Hoffman, president of Hoffman Electronics Corporation, predicted.

Mr. Hoffman attributed the expected growth of color TV to the increased programming which will be offered next year and the added exposure of color to the public. He cited specifically the announced plans for increased color broadcasting facilities on the West Coast, and NBC's commitment that, by next fall they will offer 80 hours of color program a month, as providing a powerful stimulus for color TV sales in the area.

In a recent release entitled, "A Preview of 1956," Dr. W. R. G. Baker, Vice-President, General Electric Company, states, "In looking forward to the coming year, we have every confidence that the electronics industry will more than equal 1955's record activity. Aided by a continuation of the current high national economic level, the rapid rate of advancement peculiar to the electronics business may carry us to new all-time peaks in total industry volume next year.

"Contributing to the general outlook for the electronics field for the next 12 months are the following factors:

"There will be a growth of television broadcasting in smaller market areas. Sixty-five new television stations are expected to go on the air in 1956, bringing the total to 535. More than half of these will be able to transmit color. The swing to color transmission will proceed steadily. New advances will be made in color reception. Industry retail sales of color television receivers should total approximately 150,000 in 1956. Sales of monochrome television sets are expected to total 7,100,000 next year. The steady impact of clock and portable radios will help offset a regressive movement in the table-model market. We expect that the industry will sell 7,000,000 home and portable radios in 1956. The thriving industrial radio market will continue to move upward. Total industry sales of mobile communications equipment in 1956 will show a 15 per cent increase. The new year will see transistors make a major break-through in devices for entertainment and industrial purposes as well as for military use. For the first time, transistors will be available which will reduce the size and complexity of computing machines and make them smaller and more efficient."



# flashes

John D. Van der Veer has been appointed general sales manager of Tung-Sol Electric Inc. He succeeds George W. Keown who was elected vice president of the company last month and who assumes responsibility for all sales on this date. Mr. Van der Veer joined Tung-Sol in 1945 following service in the Signal Corps as a captain. He held the position of western equipment tube sales manager until 1950 when he assumed equipment tube sales responsibility for all territories. In September, 1954 Mr. Van der Veer was named assistant general sales manager.

The Brach Division of the General Bronze Corporation recently announced that they have developed the Emerson-Brach Radiator-Rotator. The Brach control box is built into Emerson Radio sets. Actually the rotator control unit which is built within the set itself serves two purposes. A radio set and television set can be hooked up simultaneously to the antenna on top of the roof with this new device. The antenna atop the roof is rotated by a hollow torque shaft of high strength aluminum alloy which is attached to the right side of the radio.

Robert C. Sprague, Chairman of the Board of the Sprague Electric Company, North Adams, Massachusetts, receives the "Silver Knight of Management" award of the National Association of Foremen from Harold Brafman, retiring President of the Sprague Management Club, an NAF affiliate. Mr. Sprague received this award for the practice of the NAF code of ethics in his every-day business, for his loyalty to objectives of the NAF, and his efforts for the advancement of the American free enterprise system.

Jontz Mfg. Co. announces that its new colored guy rings are available—red on 16 ga. masts and green guy rings on 18 ga. masts. This has been made available to simplify identification, facilitate inventory and shipping. The colored guy rings improve the appearance from all viewpoints.

Holloway Electronics Corporation of Fort Lauderdale, Florida announces the introduction to the antenna market of their new Expo-I.R.I.S. antennas designed to eliminate interference in television reception. I.R.I.S. or Infinite Rejection Interference System, is combined with the Exponential antennas manufactured by this firm so as to eliminate co-channel, adjacent channel interference and ghosts.

In announcing the introduction of this development, R. O. Holloway, President of the firm, stated that it was a complete and fundamental answer to the interference problem, being based upon the concept that an interfering signal can be completely cancelled by an opposing signal of equal amplitude but of opposite phase. The system consists of two antennas one of which is vertically disposed above the other, cancellation of the interfering signal being accomplished by merely rotating one of the antennas. Common forms of interference such as "venetian blinds," splatter from strong local signals and ghosts are said to be completely eliminated by Expo-I.R.I.S. Both I.R.I.S. and the fundamental wide band Exponential antenna marketed by the firm are the results of years of research and development by John R. Holloway, Director of Engineering of the firm.

Color television sets will be produced in volume by the  
[Continued on page 37]

"BOY, WHAT A THRILL  
HAVING NO CALLBACKS!"



"That name Tung-Sol is sure reassuring when I replace a tube. I know it's going to stand up like Tung-Sol Tubes always have. It's this kind of dependability that helps protect my profits and my reputation and keeps customers sold on me."

**TUNG-SOL<sup>®</sup>**  
dependable  
**PICTURE TUBES**

TUNG-SOL ELECTRIC INC., Newark 4, N. J. Sales Offices:  
Atlanta, Columbus, Culver City, Dallas, Denver, Detroit, Melrose  
Park (Ill.), Newark, Seattle.

# NOW! PHOTOFACT BRINGS YOU EXTRA SCHEMATIC COVERAGE

*you get immediate coverage on leading receivers just as soon as they hit the market!*

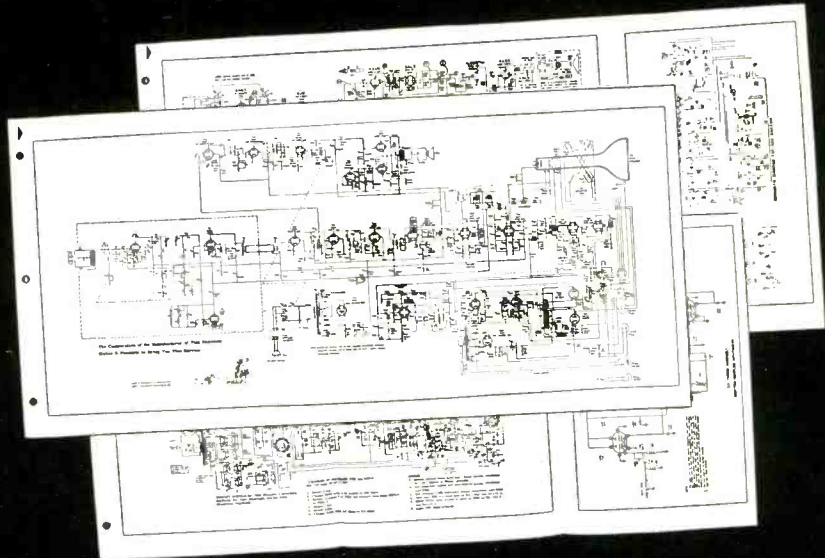

## **IT'S AN "EXTRA" SERVICE— IN ADDITION TO REGULAR COVERAGE— AT NO EXTRA COST TO YOU**

The January issues of Sams' PHOTOFACT contain the first of a series of schematic diagrams covering the nation's top manufacturers' new model releases. Look for PHOTOFACT Sets 302, 303, and 304 at your Parts Distributor today! See for yourself how PHOTOFACT keeps you current with the present output of new TV and Radio Models. Be sure to enter your "standing order" for each new monthly release of Sams' PHOTOFACT Sets—they'll put you out ahead in service work.

**remember—you get the world's finest service data —  
you get it fastest in PHOTOFACT**

**HOWARD W. SAMS & CO., INC., 2209 E. 46th St., Indianapolis 5, Indiana**



FOR BEST BLACK AND WHITE, AND **COLOR** RECEPTION...



ELIO PURA  
KING CITY-TV  
KING CITY, CALIFORNIA

WE HAVE EIGHT POSSIBLE TV CHANNELS IN KING CITY. TWO ARE SNOW-FREE, BUT THE OTHERS ARE FRINGE. THEY ARE LISTED AS FOLLOWS:

- CHANNEL 3 SOUTH  
SANTA BARBARA, CALIF.
- CHANNEL 4 NORTH  
SAN FRANCISCO, CALIF.
- CHANNEL 5 NORTH  
SAN FRANCISCO, CALIF.
- CHANNEL 6 SOUTH  
SAN LUIS OBISPO, CALIF.
- CHANNEL 7 NORTH  
SAN FRANCISCO, CALIF.
- CHANNEL 8 NORTH  
SALINAS, CALIF.
- CHANNEL 10 N/E  
SACRAMENTO, CALIF.
- CHANNEL 11 NORTH  
SAN JOSE, CALIF.

STACKING A JFD STAR-HELIX ON ROTOR MAKES POSSIBLE VIEWING ON ALL EIGHT CHANNELS.

ANY PERSON WISHING A GOOD ANTENNA INSTALLATION, "WE RECOMMEND A JFD STAR-HELIX ANTENNA."



CHARLES M. BOLINGER  
BOLINGER RADIO & TV SHOP  
CARROLLTON, MISSOURI

FOR AN AVERAGE INSTALLATION WE SIMPLY USE A SINGLE STAR-HELIX. IN A VERY DIFFICULT SPOT WE STACK TWO OF THEM. IN EITHER CASE IT DOES AN EXCELLENT JOB FOR US ON BOTH MONOCHROME AND COLOR AS WELL AS CUT ABOUT ONE-THIRD OFF THE INSTALLATION TIME.

WE NOW USE THE STAR-HELIX IN MOST LOCATIONS WHERE PREVIOUSLY IT WAS NECESSARY TO USE A STACKED ARRAY OF SOME TYPE IN ORDER TO GET SATISFACTORY RECEPTION.



VIOLET M. HOYT  
KINI POPO RADIO-TV SERVICE  
KEALAKEUA, KONA, HAWAII

"IT IS SO SIMPLE TO ASSEMBLE THAT EVEN I HAVE GONE OUT ON ANTENNA JOBS WHEN MY HUSBAND WAS BUSY IN THE SHOP, AND WITH A COUPLE OF UN-TRAINED HELPERS, HAVE MADE PERFECT INSTALLATIONS. WE ARE LOCATED 100 MILES FROM THE NEAREST TV TRANSMITTER, AND THE STAR-HELIX ANTENNA PULLS IN A BEAUTIFUL PICTURE, WITH NO GHOSTS."

JAMES S. JEWELL  
JEWELL TV-APPLIANCE CO.  
DECATUR, MICHIGAN

I RECENTLY TRIED THE JFD STAR-HELIX ANTENNA WHEN INSTALLING MY FIRST COLOR SET AND WAS MORE THAN PLEASED WITH THE RESULTS. I HAD TRIED OTHER FRINGE ANTENNAS, BUT NOTHING WAS GIVING A CONSISTENT, SNOW-FREE SIGNAL, EVEN ON BLACK AND WHITE, FROM GRAND RAPIDS-CHANNEL 8, WHICH IS ABOUT 80 MILES AWAY.

NOW WITH THE JFD STAR-HELIX, EVEN COLOR SIGNALS ARE STEADY AND FREE FROM SNOW. WE ARE ALSO RECEIVING GOOD SIGNALS FROM FAR AWAY AS 125 MILES FROM CHICAGO ON CHANNELS TWO, FIVE, SEVEN AND NINE.



JOHN A. ETCHINSON  
E. O. BROOKS APPLIANCES  
FLORA, ILLINOIS

WE ARE USING THE NEW STAR-HELIX ANTENNA AND FIND THAT IT OUT PERFORMS ANY OTHER ANTENNA WE HAVE EVER USED. FLORA IS LOCATED APPROXIMATELY ONE HUNDRED MILES FROM STATIONS EAST, WEST, NORTH AND SOUTH AND WE REQUIRE AN ANTENNA THAT WILL SEPARATE THESE STATIONS AS WELL AS BRING IN RECEPTION. THE NEW STAR-HELIX WILL DO AN EXCELLENT JOB IN SEPARATING THESE STATIONS, THUS ELIMINATING CO-CHANNEL INTERFERENCE.



EARL FRAZIER  
FRAZIER FURNITURE CO.  
BLACKWELL, OKLAHOMA

"AFTER TRYING NUMEROUS ANTENNAS HERE IN A FRINGE AREA, WE HAVE SETTLED ON STAR-HELIX BECAUSE OF ITS FRONT TO BACK RATIO. WE FIND IT IS THE FINEST ANTENNA WE HAVE USED FOR NO BACK GAIN."

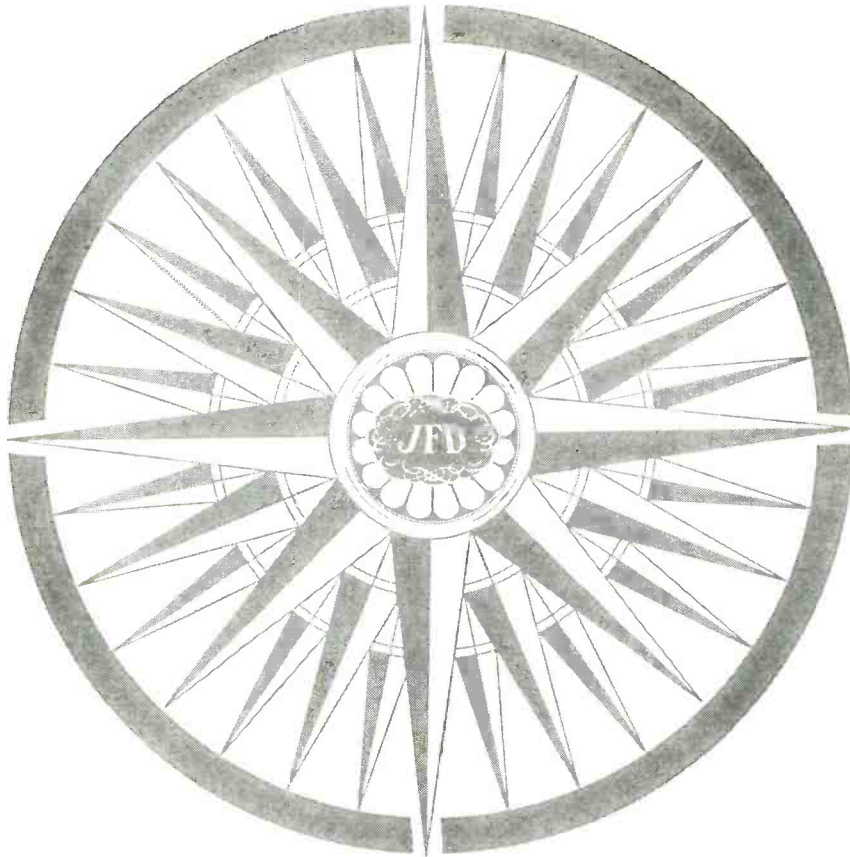

SERVICEMEN EVERYWHERE AGREE ON **JFD ANTENNAS**

EXPERIENCE IS THE BEST TEACHER. THAT'S WHY MORE AND MORE SERVICE-DEALERS, AT HOME AND ABROAD, ARE STANDARDIZING ON JFD TV ANTENNAS. THEY'VE LEARNED THAT A JFD ANTENNA ASSURES THEIR CUSTOMERS THE FINEST POSSIBLE RECEPTION IN BLACK AND WHITE TODAY, AND COLOR TOMORROW. THEY'VE SEEN HOW JFD INSTALLATIONS BUILD CUSTOMER CONFIDENCE—THE BEST INSURANCE FOR FUTURE BUSINESS. SO WHY COMPROMISE YOUR REPUTATION WHEN IT COMES TO QUALITY RECEPTION? ASK YOUR DISTRIBUTOR TO SHOW YOU THE JFD ANTENNA THAT SOLVES YOUR PROBLEM... FITS YOUR PURSE.

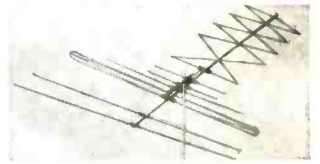

**STAR-HELIX**

- SX711 single \$25.50
- SX711S stacked \$52.50
- SX711-96\* \$55.00  
96" stacked

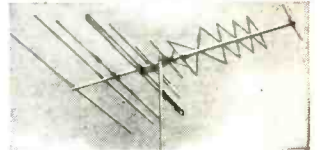

**SUPER-STAR HELIX**

- SX13 single \$35.00
- SX13S stacked \$72.50



**FIREBALL**

- FB500 single \$17.35
- FB500S stacked \$36.65
- FB500S-68† \$36.65  
68" wide stacked
- FB500S-96\* \$38.60  
96" wide stacked

\*for added ch. 2-6 gain

†for areas with co-channel and cross-channel interference



YOUR REPUTATION GOES UP WITH A JFD ANTENNA!  
**MANUFACTURING CO. INC. BROOKLYN 4, N. Y.**

INTERNATIONAL DIVISION:  
15 MOORE STREET, N. Y. C.

CANADIAN DIVISION:  
51 MCCORMACK STREET, TORONTO 14, ONTARIO

GO FORWARD WITH JFD ENGINEERING!

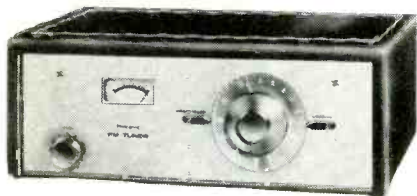

# NEW FM

This article discusses FM tuner terminology and defines in simple manner the various terms used. Circuit analyses of FM tuners and a similar discussion and treatment of AM-FM tuners will follow in succeeding issues of RTSD.



THE sole reason for high fidelity equipment is to provide entertainment that sounds right, and which gives the illusion of "presence." Otherwise, it isn't high fidelity. Frequency modulation radio reception is ideal for use with high fidelity equipment because the frequency of the sound signal is not limited as in AM, and because this type of transmission is relatively undisturbed by atmospheric noises, electrical equipment and interferences of other annoying types.

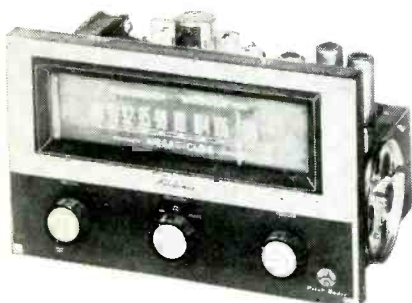

Special units are manufactured for use as components in a high fidelity sound system as illustrated in Fig. 1. One of these units, called an FM tuner, is of particular concern in this article.

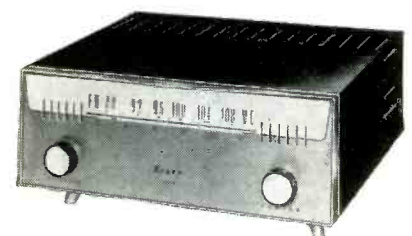

The FM tuner is a portion of a receiver in which the *rf* signal is built up to a desired value and demodulated before injection into an audio amplifier. The tuner is connected with the other components of the high fidelity system, usually an audio amplifier and loudspeaker as shown in Fig. 1. This same loudspeaker and amplifier unit may also be used for phono operation, AM broadcast tuners, tape recorders, etc. This audio amplifier system should be of a high quality type and capable of reproducing to a high degree of faithfulness the signals applied to it.



FM radio broadcasting is the ultimate in audio transmission but it must also be understood that the fidelity of sound obtained is only as good as the material transmitted, and the capabilities of the FM tuner and audio system employed to reproduce it. The job of the FM tuner is to provide a means of selecting the desired FM stations in the band from 88 to 108 *mc*. As can be appreciated it must select only the desired station and effectively attenuate all other stations. This is a measure of its selectivity.

Naturally, one of the most important attributes of an FM tuner is its ability to amplify the received signal to a level where it will be sufficient to drive an audio amplifier system and be heard.

Also, with relatively weak signal inputs, the signal-to-noise ratio of the audio output must be sufficiently high to result in good quality reproduction. Both of these factors are a measure of tuner sensitivity.

Since this tuner is to operate into a high fidelity system it must not introduce distortion in its handling of the signals, whether they be weak or very strong. Along these lines it must be able to block out interference to a high degree. The ability of an FM tuner to block out interference depends on (1) *rf* selectivity, (2) "Capture Ratio". Capture ratio measures the ability of the tuner to suppress interfering signals in the same pass-band as the desired signal.

Pointing out a few of the characteristics of FM, a well-designed receiver is less disturbed by noise and interference than an AM receiver. Also, in FM the input signal to the receiver does not remain substantially constant and may vary considerably even over a short period of time. However, with well designed limiters the audio output will remain constant with a constant percentage modulation even though the incoming signal varies over a wide range. Finally, in FM the system is inherently capable of reproducing the whole range of audio frequencies which the human ear is sensitive to. An FM receiver must be designed with greater care because the *rf* and *if* frequencies are much higher than in an AM receiver and because of the greater potential audio response range available.

Station tuning may be one of the difficulties that can be experienced with an FM tuner of inadequate mechanical design. Another possible problem is oscillator drift, but here again this is overcome by the use of high quality components such as negative temperature coefficient condensers, and auxiliary control circuits such as *afc* (automatic frequency control). Oscillator drift which can occur with temperature increases during warmup time and changes in line voltage are compensated for by these methods.



# TUNERS

Part 1

by

STEVE TRAVIS

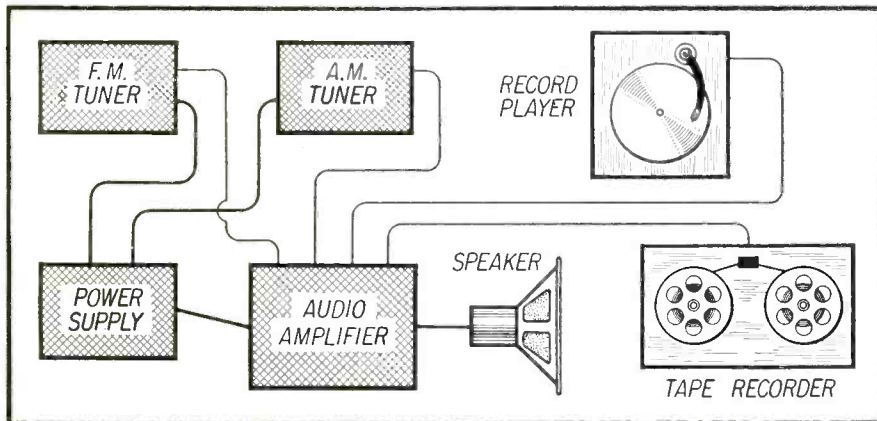
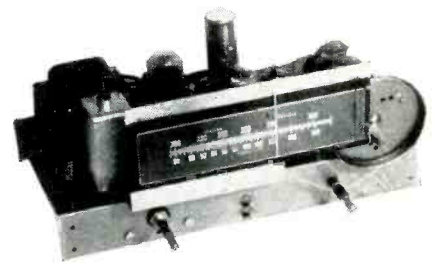

Fig. 1—Block diagram of a complete high fidelity system showing the manner in which the various units are connected to one another.



## Selecting an FM Tuner

With the great public interest in quality audio and high fidelity systems, a prominent question that arises in putting together such a system is what FM tuner is best suited for the job. FM tuners are merchandised in a great many forms, from kits to complete units with sensitivity meters and logging scales (which are auxiliary scales for rapid station selection). They are obtainable as units which contain only a tuning knob and an on-off switch, as well as units which contain bass, treble, volume, squelching, and level or gain controls; plus multiple function switches for such purposes as *afc*, *age*, etc.

One point to bear in mind in the selection of a tuner is the possibility of the duplication of controls on the tuner and amplifier. Wherever possible this should be avoided since it only leads to confusion and to unnecessarily higher cost.

An important consideration concerning FM tuners is the location of the receiver with respect to the broadcast stations. It is evident that if local reception is adequate a super-sensitive tuner is not required. A quality tuner should have other features besides sensitivity and is often judged by *what it doesn't pick up* as well as how well it pulls in weak signals. In metropolitan areas

numerous spurious signals can be received such as adjacent channel interference and image frequencies if provisions have not been designed into the tuner to prevent these disturbances from disrupting reception. Other sources of interference are television receivers, diathermy units, and ignition systems.

In the selection, then, of an FM tuner it is necessary for the technician to qualify as an expert in order to determine which tuner meets the specific needs and requirements. The variety of tuners available is so broad as far as design and performance variations are concerned that only a discussion of them can bring to light the many facets of a good tuner besides a brightly polished front panel.

## Sensitivity and Quieting Ratings

FM tuners are designed so that the limiter or ratio detector action provides noise reduction with increased signal strength. Noise reduction or quieting is expressed as a *db* ratio. A typical curve showing how noise varies with signal input is shown in Fig. 2. The noise referred to is the inherent noise generated in the tuner itself. It must be understood that provisions for better reception in the form of efficient antennas and location will result in greater signal strengths appearing at the antenna and

consequent greater signal to noise or quieting ratio.

The noise at the output of a tuner is a maximum in the absence of an *rf* signal at the input, and decreases as the *rf* signal input is increased. One way of defining the quieting sensitivity of a tuner is by specifying the amount of CW signal needed at the input to effect a specified reduction in output noise, like "10 microvolts for 20 db of quieting." The *db* ratio of the original noise output over the reduced noise output is what we see in Fig. 2 expressed as Noise Reduction in decibels.

Acceptable listening may be obtained when the noise reduction in a tuner is in the order of 20 *db* or greater. Actually, this concept classifies tuners according to the amount of noise originating in the circuits and presented at the output. This measurement is made at a time when there is no modulation of the carrier being transmitted which could mask the measured noise.

A typical expression of sensitivity might be 5 microvolts at 30 *db* of quieting. Less microvolts of signal strength for the same quieting or more *db* of quieting for the same signal strength indicates a better tuner. It is for this reason that *rf* stages in FM tuners are at present of a cascode design. Using dual triode tubes for high frequency amplification and mixing operations causes the generation of less noise in these stages than does the employment of pentode tubes for the same purpose.

### Capture Ratio

The voltage ratio in *db* between the maximum interference signal on the same passband that can be rejected and the desired signal is termed the "capture ratio."

As an example, suppose a 100 microvolt signal is being received in a tuner and the maximum value of an interfering signal at the same center frequency as the desired signal at which rejection takes place is 50 microvolts. Then, the voltage ratio between the two signals is 2 to 1 and the capture ratio is 6 *db*. Now, suppose another tuner also receiving the 100 microvolt signal does not reject an interfering signal unless it is below 10 microvolts. In this case the voltage ratio is 10 to 1 and the capture ratio is 20 *db*. It is evident that the tuner with the smaller capture ratio is more effective in rejecting interfering signals than the tuner with the high capture ratio.

A tuner having a capture ratio of 2.5 *db* is considered quite good. Tuners with comparatively low capture ratios are less susceptible to interference than tuners with high capture ratios. Interference can mean outside noise such as ignition as well as other signals. Inter-

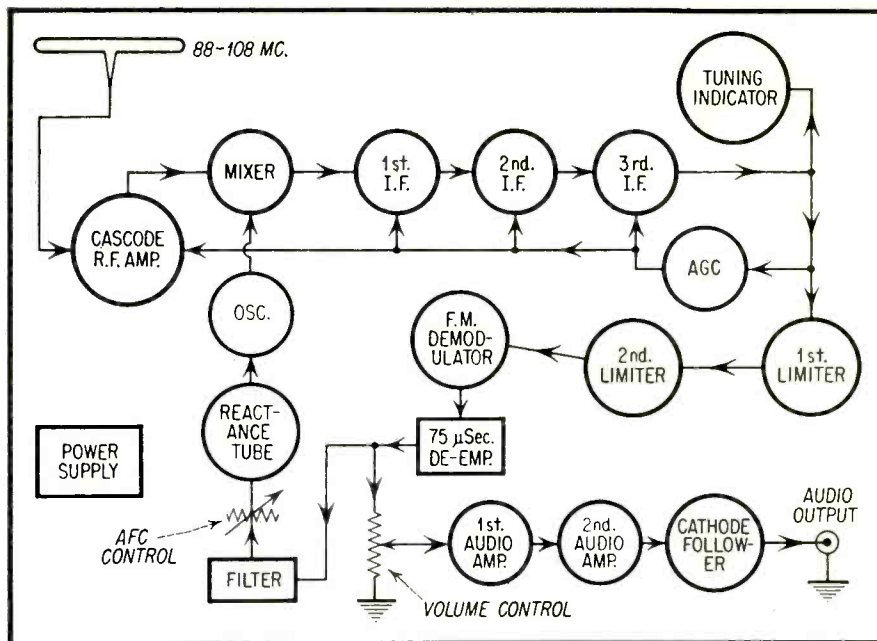

Fig. 3—Block diagram of a typical FM tuner indicating the various signal paths taken by the many signals developed in the tuner.

ference rejection is one of the most desirable features in an FM tuner.

A composite block diagram incorporating a number of features found in FM tuners is shown in Fig. 3. As can be noted in Fig. 3 a cascode stage may be employed as the *rf* amplifier. From the tuned *rf* stage the signal is applied to the mixer stage along with the proper oscillator signal.

The resultant difference frequency at the mixer circuit output is coupled to the *if* stages where additional amplification is performed. At the output of the third *if* stage a diode rectifier circuit may be employed to provide a negative voltage with which to govern the gain of the *rf* and *if* stages. This is the desired point also for a visual indication of tuning such as a sensitivity meter because limiting has not been performed

as yet on the signal. Limiting would prevent a tuning indicator or *agc* circuit from being fully responsive as these circuits and devices generally operate as a function of amplitude.

The third *if* stage feeds the first limiter circuit followed by another stage of amplitude limiting. The signal is applied from the output of the 2nd limiter to an FM demodulator stage where the audio signal is recovered.

From the demodulator circuit a *dc* potential is obtained for *afc* purposes. This voltage, negative or positive dependent upon an error in *if* frequency at the FM demodulator circuit, is supplied to a reactance stage. The reactance stage changes the oscillator tuning in response to the positive or negative voltage correcting the oscillator frequency so that the *if* signal applied to the demodulator circuit is held at the correct frequency.

The transmitted signal has been altered at the broadcast station to accentuate the high audio frequencies above their normal level with respect to the frequencies below 1000 *cps*. This is called pre-emphasis and is used for achieving a better signal to noise ratio in the output audio signal. At the receiver, the increase in amplitude of the frequencies above 1000 *cps* must be brought back to its normal level. This is achieved through the use of a de-emphasis network.

From this point the audio signal is developed across a volume control which permits adjusting the level of audio voltage applied to the first audio amplifier. The second amplifier increases the audio level further and the signal is coupled to a cathode follower

[Continued on page 47]

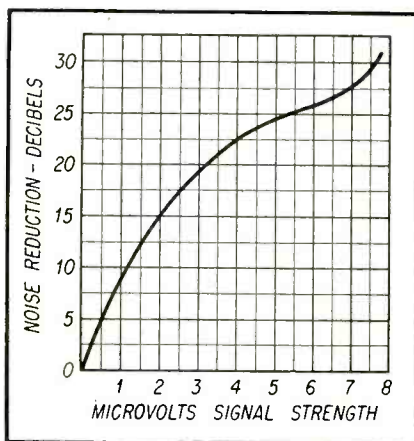

Fig. 2—Graph illustrating noise reduction in *db* versus signal strength in microvolts (*uv*).





**GENERAL  
CEMENT MFG. CO.**

- SERVICE AIDS
- CHEMICALS
- ALIGNMENT TOOLS

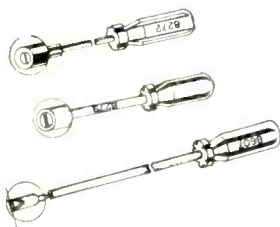

Everything you need for successful radio-television servicing is available in the big G-C line . . . at leading parts distributors everywhere.

**GENERAL CEMENT MFG. CO.**  
919 Taylor Avenue • Rockford, Illinois



**G-C ELECTRONICS  
MFG. CO.**

**G-C Stackpole Carbon Resistors**

Scientifically Packaged  
to Prevent Bent  
Soldering Leads



A complete line  
of 78 values to  
meet every  
requirement . . .  
color coded for  
quick, easy  
identification.

**60 LINE  
CARBON RESISTORS**  
ALL ONE PRICE . . .  
ONE STANDARD PACKAGE  
LIST \$1.00 per BOX  
DEALER NET **60c**  
PER BOX



**G-C ELECTRONICS  
MFG. CO.**  
Division of General  
Cement Mfg. Co.  
919 Taylor Avenue  
Rockford, Illinois



**TELEVISION  
HARDWARE MFG. CO.**

*Headquarters for all TV Hardware*

- ROOF MOUNTS
- STAND-OFFS • LIGHTNING ARRESTORS
- TOWERS • CHIMNEY MOUNTS
- WALL MOUNTS • ACCESSORIES



TELCO Hardware makes every antenna installation easier, more profitable . . . a complete line for servicemen everywhere.

**TELEVISION HARDWARE MFG. CO.**  
Division of General Cement Mfg. Co.  
919 Taylor Avenue  
Rockford, Illinois



**TELCO ELECTRONICS  
MFG. CO.**

*Telco UHF-VHF Antennas*

Whether it's price, distance, UHF or VHF, indoor or outdoor . . . you'll find the antenna you need at TELCO.

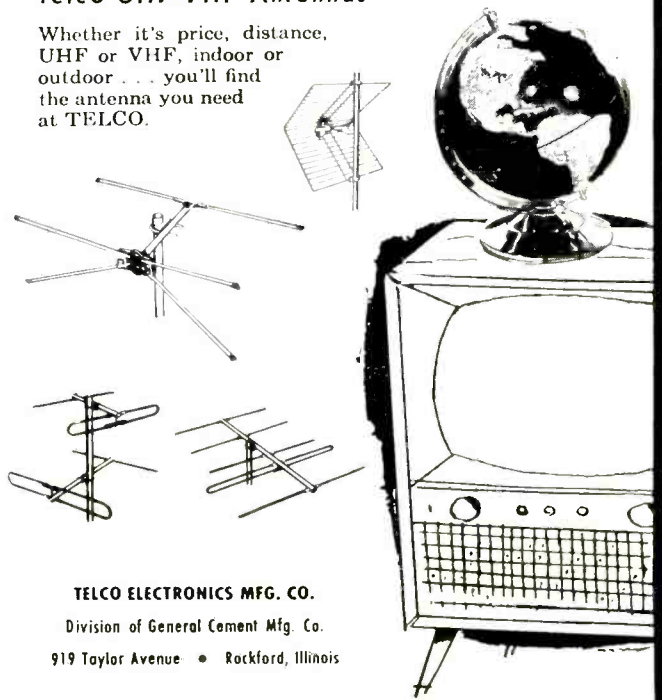

**TELCO ELECTRONICS MFG. CO.**  
Division of General Cement Mfg. Co.  
919 Taylor Avenue • Rockford, Illinois

# RIDER SPEAKS

**M**OST hi-fi fans cannot repair their own equipment. For that matter, most of them do not understand the functioning of the component parts. But this does not in the slightest dim their pride in their possession—or deter them from bragging a little about how and why their setup is better than some other. Each owner has developed a fairly deep mental impression of what his equipment can do—of how every record he plays “sounds.” It’s like a stamp collector who somehow or other has a mental image of *every* stamp in his collection.

When something goes wrong and someone must be called in to make the repair, the hi-fi fan begins to worry. Whom should he call? What assurance does he have that the technician will do a good job? Do TV technicians know anything about hi-fi? The feeling of anxiety grows stronger and stronger. Maybe it would be best to send the equipment back to the factory—they must know everything about it. But the packing is such a task—and how long would they keep it? Would it arrive undamaged? No, maybe it’s best to try to find a good repair man in town. Where to look—whom to ask—to find this individual. These are troublesome thoughts.

Finally, someone is selected. The job is done and the equipment is again in operation. Critical listening begins and with it a new period of concern. It just doesn’t seem to sound right. Did the repair man use the right parts? Did he know what he was doing?

As the feeling of suspicion grows, many more things seem to be wrong.

How can the servicing industry avoid such a situation? The first step is to know the *correct* performance of the equipment as produced by the manufacturer, not by guessing but by having and using the correct information. The manufacturer should furnish the hi-fi equipment purchaser with a full set of specifications covering the performance. This is done by many in the form of frequency response curves, gain figures, impedance values, and the like. Unfortunately, it is not done by all manufacturers.

The service information covering the devices should be complete in detail, especially as it relates to those components which are critical in their effect on the overall performance of the device. Withholding such information from a service manual in an effort to



promote factory repair (or the purchase of components from the factory) is creating obstacles to increased hi-fi equipment sales. Admittedly, many hi-fi enthusiasts send defective equipment back to the factory for repair, but to make this a necessity is to deter the growth of hi-fi.

Local service facilities are as necessary for hi-fi equipment as for automobiles, deep freezers, washing machines, and radio and television receivers. The fact that the choice of components and their integration in a system is more critical in a hi-fi installation than in other home electronic devices is not license to deny local service. Unavailability of local service can be a hindrance to sales, whereas the presence of such service can be a stimulant. It should not be surprising to see those devices that are readily serviceable outdistancing in sales those that are not.

A person who spends hundreds or even thousands of dollars for an electronic installation in the home is entitled to rapid and efficient service on the spot—at least somewhere in the community where he lives. It is unfortunate that even under most favorable conditions, all the components used in the many brands of hi-fi systems sold throughout the nation cannot be stocked by the electronic parts distributors for purchase by local service technicians. The situation should be relieved as much as possible by the dissemination of the maximum amount of service information.

The servicing industry also has responsibilities. It can’t compromise with quality in a hi-fi system repair. Such a compromise is too easily recognized. The service technician must make use of the performance specifications that are part of the hi-fi manufacturers’ service literature to determine whether the repair was correctly made. The equipment performance after repair must meet the specifications. If the service facility does not have its own file, it should use for comparison the material

given to the purchaser by the manufacturer of the equipment.

It is not difficult to repair a defect in a hi-fi system, but a background in the subject is necessary. It must be done carefully. A reduction or a change in frequency bandpass in a radio receiver or, for that matter, even in a television receiver, often passes unnoticed. Not so with the critical ear of the hi-fi fan. A misplaced lead can adversely affect the normally controlled feedback, prevent complete control of a signal; in general, impair the performance.

The average service technician looks upon a sound reproducing system as something uncomplicated. This is true as far as the schematic is concerned, but when a number of different devices (a tuner, a record player, a tape recorder, a pre-amplifier, an amplifier, a mixer and/or one or more loudspeakers), must be tied together into an integrated system, it is not a casual job.

Each part contributes to the whole; each part must be “matched” to the other. Each part must function correctly with the other—it must be an integrated system.

Many service technicians are of the impression that only television service offers financial rewards. This is not true. The individual who has hi-fi as a hobby usually spends a substantial amount of money for his equipment, and is prepared to pay adequately for *good* service. Remember, he takes pride in what he owns! Remember that his hi-fi equipment is satisfying the inner man. No such thing exists with radio or television equipment. A hi-fi system is always a prideful possession: in comparison, a radio receiver or a television receiver is an ordinary appliance.

Unlike the owner of a television receiver the hi-fi fan makes it his business to learn something about his equipment. Even if he does not know the underlying theory, he knows what each part of the equipment contributes to the end product. The service technician who desires to build confidence in the mind of the hi-fi fan must be prepared to *talk the language of the hobby*. He must display a familiarity with varieties of the equipment as well as with the techniques of repair.

Hi-fi servicing is good business and, if the past is any barometer of the future, the sales and service of high-fidelity equipment are destined to boom to substantial heights.

JOHN F. RIDER





# Silver Vision

**THE ALUMINIZED TUBE THAT IS PRE-SOLD**

Sure, *you* are already sold on the advantages of aluminized tubes. You know that the CBS Silver Vision aluminized screen with its silver-activated phosphors and the CBS small-spot gun mean clearer, sharper, brighter pictures.

But your woman customer (76.9% of TV service customers are women) doesn't understand electronics or CBS advanced-engineering as you do.

She does know and respect the name CBS . . . she has confidence in Garry Moore and in the Good Housekeeping Guaranty Seal.

So all you have to do is take advantage of Garry's pre-selling over the CBS Television Network. Just remind her that there are no finer tubes made than CBS Silver Vision tubes . . .

And, like all CBS tubes, they have the Good Housekeeping Guaranty Seal. She's already pre-sold by Garry Moore and national magazine advertising. You build profitable customer confidence and sales every time you recommend CBS Silver Vision tubes.

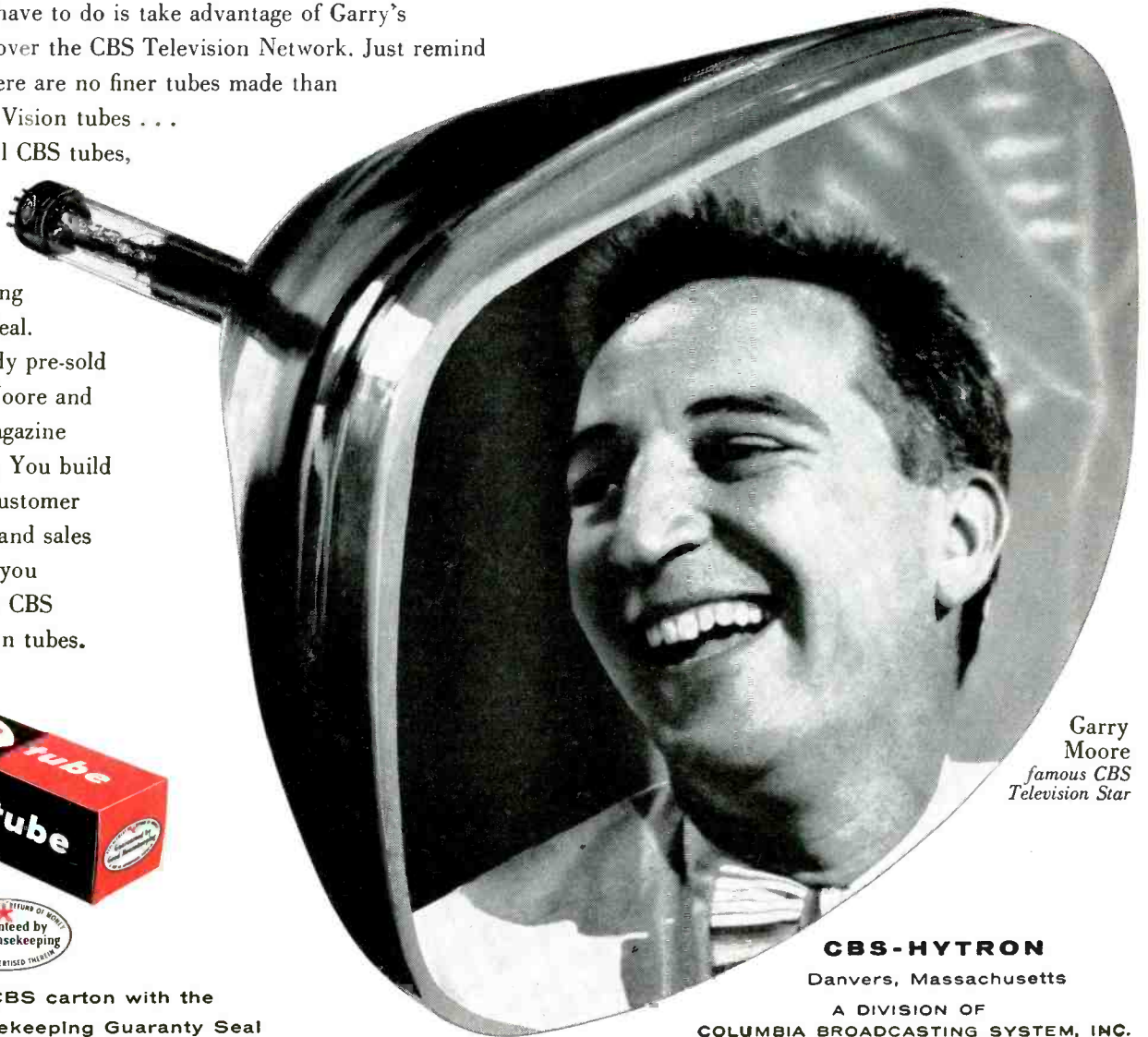

Garry Moore  
famous CBS  
Television Star



Show the CBS carton with the Good Housekeeping Guaranty Seal

**CBS-HYTRON**

Danvers, Massachusetts

A DIVISION OF  
COLUMBIA BROADCASTING SYSTEM, INC.

**COMING IN  
FEB. '56**

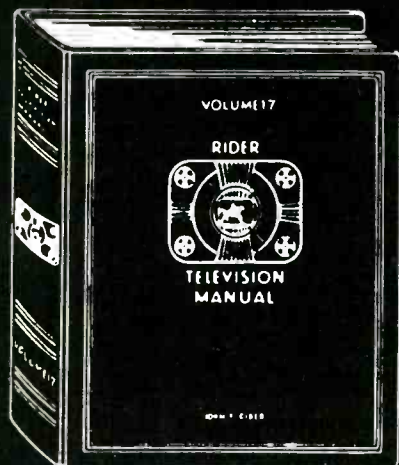

**RIDER'S  
TV 17!**

**LIMITED PRINTING—**  
*tell your jobber to  
reserve your copy now!*  
**only \$24.**

**TELEVISION—HOW IT WORKS  
(2nd Edition)**

by J. RICHARD JOHNSON

Completely rewritten and revised. This book explains the how and why of modern television receivers in the simplest and most direct terms. Text follows received signal from the antenna to picture tube and loudspeaker. Review questions follow each chapter. Specially conceived artwork illustrates book dramatically. Ideal for service man, student, experimenter and hobbyist.

Only \$4.60.

**COLOR TELEVISION RECEIVER PRACTICES**  
by HAZELTINE CORP. Laboratories Staff

Every chapter of this book deals with a separate portion of the receiver, and is written by a different Hazeltine Laboratory expert. Every major aspect of color receivers is analyzed and thoroughly explained, with latest 21" picture and circuitry. Each chapter has summary of important points. A "must" for everyone who wants a solid grounding in color!

Only \$4.50.

Buy these books now from your jobber... bookstore... If not available from these sources, write to:

**JOHN F. RIDER** PUBLISHER, 480 Canal St.,  
INC. New York 13, N. Y.

# ASSOCIATION NEWS

by Samuel L. Marshall

**National Alliance of TV and  
Electronic Service Associations**

The following release from NATESA is reproduced in its entirety in order to present NATESA's side of the present controversy centered around the recent unity meeting at Indianapolis.

"Numerous press releases have been issued by a few delegates to the service unity meeting at Indianapolis who participated in the unanimous vote to accept NATESA as *the* national association, but who now are going back on their word. The phraseology of these releases bears remarkable similarity to those of a publisher of a so-called service management magazine who has long had ambitions to control the service industry through a captive association and the use of his magazine as the voice of the group.

"To recognize the insincerity of the charges being made it should be recognized that NATESA had less than 1/3 of the total vote at the meeting. The president of NATESA is being falsely charged with dictatorship simply because he has been doing, and we are quoting one of their releases, 'three jobs' without compensation and 'there are too few persons with the initiative, time and ability to carry out the duties of *one* of these jobs, much less all three,' and for that reason was reelected in open elections five times. Would a dictator publicly offer to resign and disavow any office as did the NATESA president at Indianapolis, and in print?

"The second false charge is that made against the organizational set-up of NATESA which has been in effect since the first days of NATESA. Originally, three divisions were created. These have been expanded as NATESA grew. Full recognition is given state groups. The opponents of NATESA give credit for origination of this set-up to a Texas group which has such plans for the future. The "State Supremacy" group would deprive 3/4 of all local groups of a voice since very few state groups exist. Is this an example of their lack of knowledge of the independent service industry, or are their plans insidious?

"NATESA has offered to waive its right to challenge applications of quali-

fied groups if they are submitted by a specified date; the NATESA president has offered to resign; NATESA, at its cost, distributed copies of the Indianapolis meeting minutes, its Constitution, organizational system and other materials, to the non-affiliates who attended the meeting; NATESA has for five years mailed large numbers of informational bulletins and for three years each copy of the SCOPE free to over 200 non-affiliated local groups; it has, at no cost, mailed copies of its 'Here's How' brochure to help new groups organize; NATESA personnel has made personal visits to many cities at their own expense, to help many new associations. Can any of the NATESA opponents make these statements truthfully? Why have these groups repeatedly refused to cooperate and reciprocate?"

**Association of TV Service  
Companies, Cincinnati, Ohio**

ATSCO is ready to launch a License Agreement program aimed to further the goal of higher standards in the service industry. This agreement is intended to license and regulate persons, partnerships, firms or corporations, who are members of ATSCO, engaged in the business of repairing and servicing TV sets, radios or other electronic devices in the metropolitan area of Greater Cincinnati, deemed necessary for the preservation of the public peace, health and safety.

**Radio TV Assoc. of  
Santa Clara Valley, Calif.**

RTASCV's campaign to bring KSBW-TV's advertising program into line consistent with its reception has turned to U. S. Government sources for support. Association Executive Secretary Wes Strouse appealed to the Federal Communications Commission last month for aid in the Association's campaign which began last Summer with written protest to the Salinas station. Strouse opened his campaign after RTASCV men condemned Channel 8's "Look at 8 It's Great" ad series in media that covered Valley and Peninsula areas where Eight's signal generally was weak. Set owners in San Jose and northward

[Continued on page 46]





Superior's  
New Model TV-12

# TRANS-CONDUCTANCE TUBE TESTER

### TESTING TUBES

- ★ **Employs improved TRANS-CONDUCTANCE circuit.** An in-phase signal is impressed on the input section of a tube and the resultant plate current change is measured. This provides the most suitable method of simulating the manner in which tubes actually operate in Radio & TV receivers, amplifiers and other circuits. Amplification factor, plate resistance and cathode emission are all correlated in one meter reading.
- ★ **NEW LINE VOLTAGE ADJUSTING SYSTEM.** A tapped transformer makes it possible to compensate for line voltage variations to a tolerance of better than 2%.
- ★ **SAFETY BUTTON**—protects both the tube under test and the instrument meter against damage due to overload or other form of improper switching.

★ **NEWLY DESIGNED FIVE POSITION LEVER SWITCH ASSEMBLY.** Permits application of separate voltages as required for both plate and grid of tube under test, resulting in improved Trans-Conductance circuit.

### TESTING TRANSISTORS

A transistor can be safely and adequately tested only under dynamic conditions. The Model TV-12 will test all transistors in that approved manner, and quality is read directly on a special "transistor only" meter scale.

The Model TV-12 will accommodate all transistors including NPN's, PNP's, Photo and Tetraodes, whether made of Germanium or Silicon, either point contact or junction contact types.  
Model TV-12 housed in handsome rugged portable cabinet sells for only

**\$7250**  
NET

ALSO TESTS TRANSISTORS!

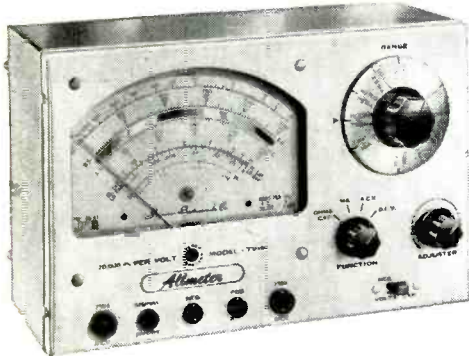

Superior's New  
Model TV-60

# 20,000 OHMS PER VOLT ALLMETER

Includes services never before provided by an instrument of this type. Read and compare features and specifications below!

### FEATURES

- Giant RECESSED 6 1/2 inch 40 Microampere meter with MIRRORED scale.
- Built-in Isolation Transformer.
- Use of the latest type PRINTED CIRCUIT and 1% multipliers assure unchanging accurate readings.

### SPECIFICATIONS

- 8 D.C. VOLTAGE RANGES: (At a sensitivity of 20,000 Ohms per Volt) 0 to 15.75, 150/300/750/1500/7500/30,000 Volts.
- 7 A.C. VOLTAGE RANGES: (At a sensitivity of 5,000 Ohms per Volt) 0 to 15.75, 150/300/750/1500/7500 Volts.
- 3 RESISTANCE RANGES: 0 to 2,000/200,000 Ohms, 0-20 Megohms.
- 2 CAPACITY RANGES: .00025 Mfd. to 30 Mfd.
- 5 D.C. CURRENT RANGES: 0-75 Microamperes, 0 to 7.5/75/750 Milli-amperes, 0 to 15 Amperes.
- 3 DECIBEL RANGES: -6 db to +58 db.

**R.F. SIGNAL TRACER SERVICE:** Enables following the R.F. signal from the antenna to speaker of any radio or TV receiver and using that signal as a basis of measurement to first isolate the faulty stage and finally the component or circuit condition causing the trouble.

**AUDIO SIGNAL TRACER SERVICE:** Functions in the same manner as the R.F. Signal Tracing service specified at left except that it is used for the location of cause of trouble in all audio and amplifier systems.

Model TV 60 comes complete with book of instructions; pair of standard test leads; high-voltage probe; detachable line cord; R.F. Signal Tracer Probe and Audio Signal Tracer Probe. Pliofilm bag for all above accessories is also included. Price complete. Nothing else to buy. ONLY

**\$5250**  
NET

Superior's New Model TV-50

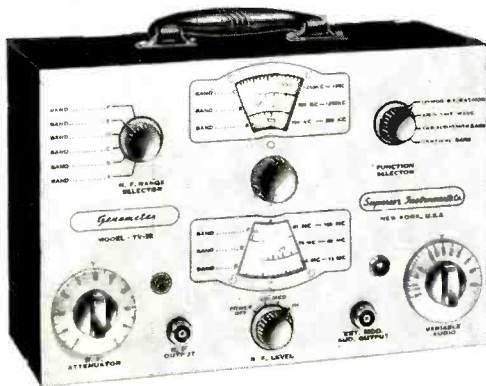

# GENOMETER

A versatile all-inclusive GENERATOR which provides ALL the outputs for servicing:  
A.M. Radio • F.M. Radio • Amplifiers • Black and White TV • Color TV

**R. F. SIGNAL GENERATOR:** The Model TV-50 Genometer provides complete coverage for A.M. and F.M. alignment. Generates Radio Frequencies from 100 Kilocycles to 60 Megacycles on fundamentals and from 60 Megacycles to 180 Megacycles on powerful harmonics.

**VARIABLE AUDIO FREQUENCY GENERATOR:** In addition to a fixed 100 cycle sine-wave audio, the Model TV-50 Genometer provides a variable 300 cycle to 20,000 cycle peaked wave audio signal.

**BAR GENERATOR:** The Model TV-50 projects an actual Bar Pattern on any TV Receiver Screen. Pattern will consist of 1 to 16 horizontal bars or 7 to 20 vertical bars.

### 7 Signal Generators in One!

- ✓ R.F. Signal Generator for A.M.
- ✓ R.F. Signal Generator for F.M.
- ✓ Audio Frequency Generator
- ✓ Bar Generator
- ✓ Cross Hatch Generator
- ✓ Color Dot Pattern Generator
- ✓ Marker Generator

**CROSS HATCH GENERATOR:** The Model TV-50 Genometer will project a cross-hatch pattern on any TV picture tube. The pattern will consist of non-shifting horizontal and vertical lines interlaced to provide a stable cross-hatch effect.

**DOT PATTERN GENERATOR (FOR COLOR TV)** Although you will be able to use most of your regular standard equipment for servicing Color TV, the one addition which is a "must" is a Dot Pattern Generator. The Dot Pattern projected on any color TV Receiver tube by the Model TV-50 will enable you to adjust for proper color convergence.

**MARKER GENERATOR:** The Model TV-50 includes all the most frequently needed marker points. The following markers are provided: 189 Kc., 202.5 Kc., 356 Kc., 600 Kc., 1000 Kc., 1400 Kc., 1600 Kc., 2000 Kc., 2500 Kc., 3579 Kc., 4.5 Mc., 5 Mc., 10.7 Mc., (3579 Kc. is the color burst frequency.)

THE MODEL TV-50 comes absolutely complete with shielded leads and operating instructions.

**\$4750**  
NET

# SHIPPED ON APPROVAL NO MONEY WITH ORDER — NO C.O.D.

Try any of the instruments on this page for 10 days before you buy. If completely satisfied then send down payment and pay balance as indicated on coupon. No interest or Finance Charges Added! If not completely satisfied return unit to us, no explanation necessary.

**MOSS ELECTRONIC DISTRIBUTING CO., INC.**  
Dept. D-209, 3849 Tenth Ave., New York 34, N. Y.

Please send me the units checked. I agree to pay down payment within 10 days and to pay the monthly balance as shown. It is understood there will be no finance, interest or any other charges, provided I send my monthly payments when due. It is further understood that should I fail to make payment when due, the full unpaid balance shall become immediately due and payable.

Model TV-50 Total Price \$47.50  
\$11.50 within 10 days. Balance \$6.00 monthly for 6 months.

Model TV-60 Total Price \$52.50  
\$12.50 within 10 days. Balance \$8.00 monthly for 5 months.

Model TV-12 Total Price \$72.50  
\$22.50 within 10 days. Balance \$10.00 monthly for 5 months.

Name \_\_\_\_\_  
Address \_\_\_\_\_  
City \_\_\_\_\_ Zone \_\_\_\_\_ State \_\_\_\_\_

By popular demand, the serviceman's most-wanted book, **Video speed Service Systems Vol. 1** is now also available in a low cost **PAPER BOUND COVER EDITION**

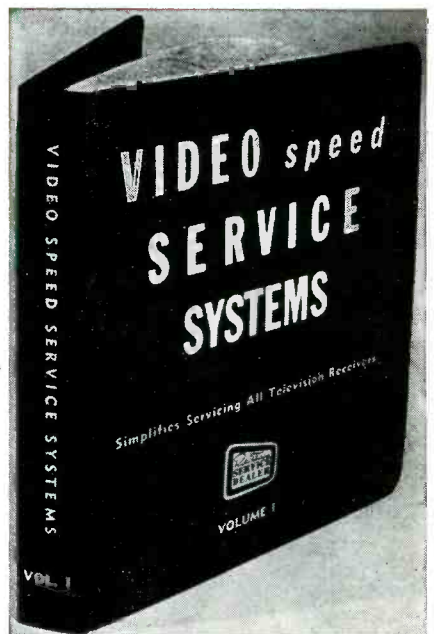
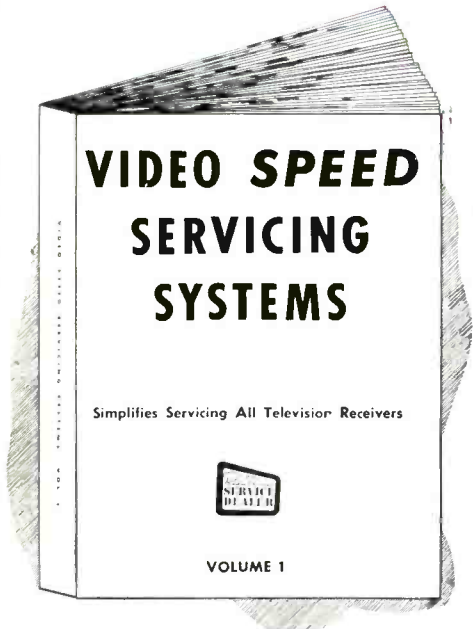

TAKE  
YOUR  
CHOICE

← New Hard Paper Cover  
Bound Edition

**\$2.95**  
Postpaid

Cloth-Covered  
Ring Binder →

**Edition \$4.95**  
Postpaid

(New York City Residents, add 3% to cover city sales tax)

Distributors — Order your supply now. Service Dealers, order from your distributor. If he can't supply you, order direct by mail from us.

Has the identical contents of the Ring Binder Edition but the price is only **\$2.95**

**Facts About Video speed Service Systems :**

**CONTENTS:**

A compilation of specific receiver service repairs, "bugs", chronic troubles, field circuit changes, manufacturers' production revisions, etc. The compilation enables the service technician to pin-point what is wrong with any given TV set and to correct the fault in the shortest possible time.

**SOURCES:**

The material was obtained directly from manufacturers, distributors' service departments, TV service organizations, and top TV Service-dealers throughout the country. Furthermore — all material has been checked carefully to assure dependability and accuracy.

**USES:**

The VSSS data sheet for any particular TVset maker's model or chassis number gives: 1—the section of the set affected; 2—the symptom; 3—the cause of complaint; 4—the solution, in simple, understandable and usable form.

Video Speed Service Systems is guaranteed to simplify servicing all TV sets. Contains over 600 service items representing over 2500 of the most serviced TV models now in use. Over 25 different manufacturers' lines are covered. Almost 15,000 copies of VSSS have been sold at \$4.95. Every technician needs a copy.

**CUT OUT AND MAIL**

COWAN PUBLISHING CORP., 67 WEST 44TH STREET, NEW YORK 36, N. Y.

Please send me postpaid Video speed Service Systems Vol. 1 in  Paper Bound Edition for \$2.95 . . . or  Hard Cover Ring-Binder Edition for \$4.95. My check for \$ . . . is enclosed. (If you reside in New York City add 3% to cover city sales tax.)

Name .....

Address .....

City ..... Zone ..... State .....



# The ANSWERMAN

Inquiries Sent To The Answerman Will Be Acknowledged Only If Accompanied By Radio-TV Service Firm Letterheads Or Similar Identification.

by **RTSD**  
Technical Staff

Dear Sir:

I had a Philco TV-390 chassis that exhibited a no sound, no picture condition. I changed the tubes in the *if* circuit and tuner but this did not restore the receiver to operation. So, it was necessary to remove the chassis from the cabinet. Physical examination revealed that a resistor was burned and my voltmeter showed that there was no voltage to the *if* strip. The burned 220 ohm resistor, R25 was replaced. But still no picture.

I adhered to my strict policy of making sure the tubes are not the cause of any difficulties and found that the 6AM8 tube was defective. Upon replacing this tube everything returned to normal.

I have been wondering whether I just ran into a receiver that contained two troubles or did the 6AM8 tube cause the 220 ohm resistor to become defective.

T. F.  
Harrisburg, Pa.

As can be noted in Fig 1, the Philco TV-390 chassis employs the audio output tube to develop the voltage drop that provides the lower B plus voltage of 145 volts for low potential operations.

From appearances the 6AM8 tube evidently shorted internally between suppressor and plate, in this case, causing the resistor R25 to pass too much current and burn open. The 6AM8 tube has failed a few times in this fashion. Frequently the short has occurred between the suppressor and screen elements.

It is suggested that a two watt unit be used in replacement of the 220 ohm resistor, R25.

Dear Mr. Answerman:

In a Magnavox model CTA404B TV receiver I have an unusual condition. I can't get picture or sound through the chassis and to the best of my knowledge nothing is wrong with the tuner or *if* strip. The only voltage

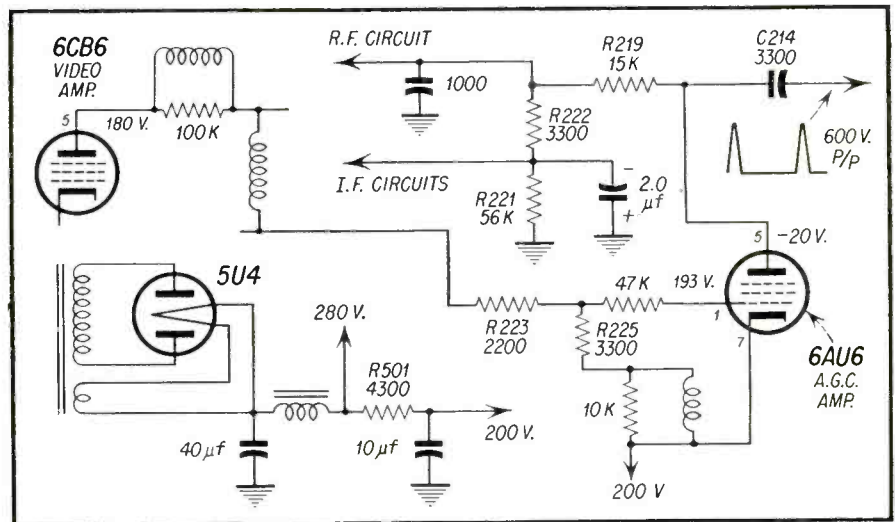

Fig. 2—Partial schematic of Magnavox Model CTA 404-B.

that is different that I have found is the plate voltage on the video amplifier tube, 6CB6. This potential is low.

One point that might be of help is that when any of the horizontal tubes such as the horizontal oscillator, output or damper tube is removed from the chassis sound comes in but I don't understand what this indicates.

H. P.  
Los Angeles, Cal.

In examining Fig. 2 it can be noted that the B plus voltage of 200 volts is fed to the 6AU6 age amplifier tube. This voltage is reduced by resistors R223 and R225 and then supplied to the plate circuit of the video amplifier tube, 6CB6. Take particular note that the 200 volts B plus is applied to the cathode of the gate tube. This voltage acts as a bias voltage on the tube. The pulse from the winding on the horizontal output transformer, being a positive going voltage, must be larger than 200 volts before it can cause conduction to occur through the tube and the charging of condenser C214, 3300 μf. This charge taken by the condenser due to conduction in the tube then flows through the associated resistors, R219, R222 and R221 developing a negative voltage for the biasing action of the age system to govern the *rf* and *if* stages.

Of course, this presupposes that a positive going video signal is being applied to the grid of the age amplifier tube in phase with the horizontal pulse. The conduction in the tube is in proportion to the amplitude of the signal applied to the grid since the pulse from the horizontal circuit is constant in amplitude. A point has been made to include this pulse in Fig. 2 to show how it affects the circuit action.

[Continued on page 39]

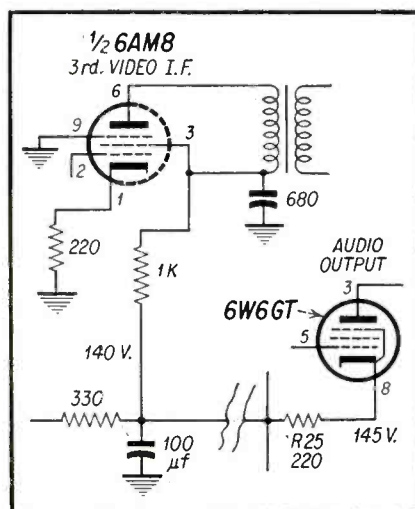

Fig. 1—Partial schematic of Philco TV 390 circuitry.

# ZENITH Remote

## Simplified Explanation Of

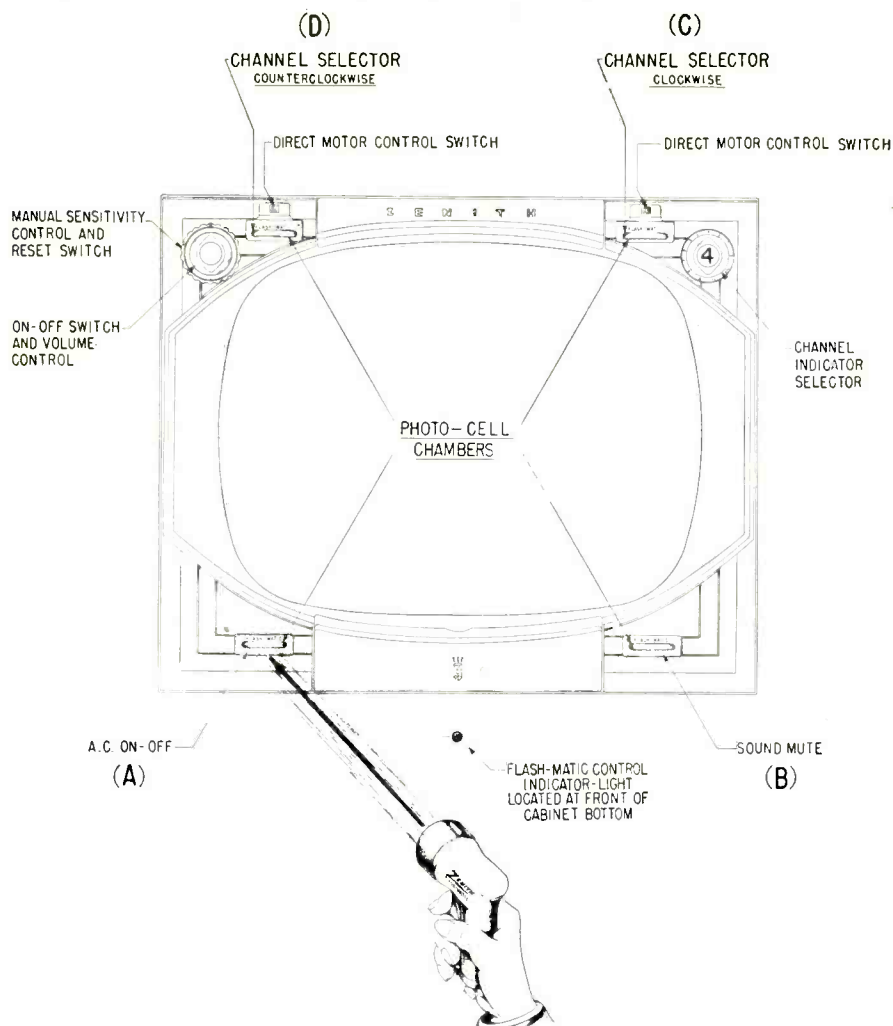

Fig. 1—Functional view of Flash-Matic in operation.

by **Oscar Fisch**

THE schematic diagrams included in the back pages of this issue cover the complete line of Zenith TV receivers for 1956. The outstanding innovation introduced by Zenith in this line is the inclusion of a unique type of remote control in some of these models. The letter "Q" following any model or chassis number indicates that the receiver is equipped with this new "Flash-Matic" remote control. In line with our established policy of keeping the service industry up to date on new circuitry, the following description and analysis of this control unit is presented.

The "Flash-Matic" remote control system differs from most others in that no connecting wires are needed between the control point and the receiver. This is accomplished by using a beam of light from a flashlight to actuate any one of four different control circuits. The following remote operations are possible:

1. The receiver may be turned on or off.
2. The sound may be muted (during commercials for example).
3. The desired channel may be se-

lected. This operation may be accomplished in either of two ways:

- a) By clockwise rotation of the tuner
- b) By counter clockwise rotation of the tuner.

Each of these operations requires its own control circuit and its own photoelectric cell. Fig. 1 indicates the location of the photocell chambers for each function.

The diagram of the complete control unit may be seen by referring to the schematic in the Zenith schematic insert included in the back section of this issue. To clarify our discussion, we shall use separate partial schematics for each of the control functions discussed. It is suggested that a copy of these partial schematics be placed in your files, since they will simplify the problem of circuit tracing when trouble develops.

### "ON-OFF" CONTROL CIRCUIT

#### Basic Principle of Operation

Figure 2 is a partial schematic which includes only those portions of the circuit involved in the "ON-OFF" control function. It is drawn to facilitate following the circuits through the various plugs and sockets which connect the control unit to the receiver. For example, the lower end of the "Manual Sensitivity Control" is shown connected to

ground by going through pin #4 of Plug (P) #4, pin #4 of Socket (S) #4, pin #6 of Plug #2, and pin #6 of Socket #2.

The basic operation of the circuit is as follows. V1, the 2D21 is a thyratron. R3, the manual sensitivity control, and B7, the "on-off" sensitivity control are adjusted so that the grid of V1 is biased beyond cut off under normal room lighting conditions. (R3 is adjusted to compensate for different room lighting conditions.) When light strikes the photo cell, it causes the grid to be raised above cut-off (explanation below) and triggers the 2D21 into conduction. The plate current of the 2D21 actuates the solenoid in the plate circuit which in turn actuates the switch SW1. One set of contacts on this switch is in series with one side of the ac line supplying the power transformer for the TV receiver, thus giving "on-off" control.

### Photocell Circuit

Referring to Fig. 2, it will be seen that the control grid of V1 is biased by the voltage it receives from the arm of the potentiometer R7. One end of this control is connected to -16 V dc derived from the selenium rectifier, SE1. The other end is connected through the photocell, a 27K resistor, and the arm of R3, to a positive voltage derived from the selenium rectifier SE-2.

The photocell is of the resistive type. This simply means that when light strikes the cell, it causes a change in resistance between its terminals. Thus, in total darkness, the cell may exhibit a resistance as high as 100 megohms, whereas if the cell is illuminated by intense light, its resistance may drop to as low as 25,000 ohms.

The voltage applied to the grid of V1 is the voltage between the arm of R7 and ground. This consists of the drop across the 47K resistor plus the drop across the portion of R7 between the arm and this 47K resistor. Now consider the condition when little or no light falls on the photocell. Since the selenium rectifier SE-1 is connected to



# Flash-Matic Control

## Its Operation And Service

produce a negative voltage, there would be an electron flow from SE-1 through the 22K and the 47K resistors to ground. This makes grid end of the 47K resistor about 16 volts negative. At the same time the positive voltage from SE-2 tends to cause an opposing current through the 47K resistor. The strength of this opposing current depends on the total resistance in the path from the arm of R3 to ground. The voltage drop across this 47K resistor depends on the *net* current through it. Thus, if downward flow produced by SE-1 were the only current present, the voltage across the 47K resistor would be 16V negative at the grid end. Any contribution of current by SE-2, through the series

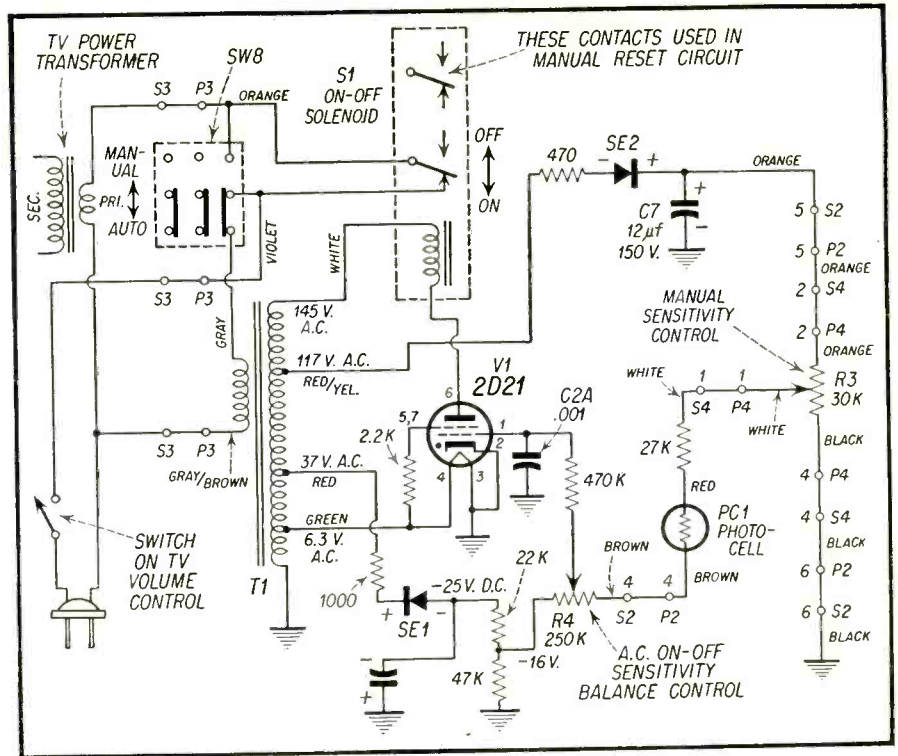

Fig. 2—Partial schematic of "On-Off" control circuit.

path of the 47K resistor, R4, and the 27K resistor will make the grid more positive by:

- Making the grid end of the 47K resistor less negative
- By adding whatever positive voltage is developed across the portion of R4 between the arm and the 47K resistor.

In the case we have chosen, namely, little or no light striking the photocell, the photocell presents a very high resistance. The upward current through the 47K resistor is thereupon very small and the grid is essentially 16 volts negative, or beyond cut-off. When light now strikes the photocell, its resistance is greatly decreased, the current in its

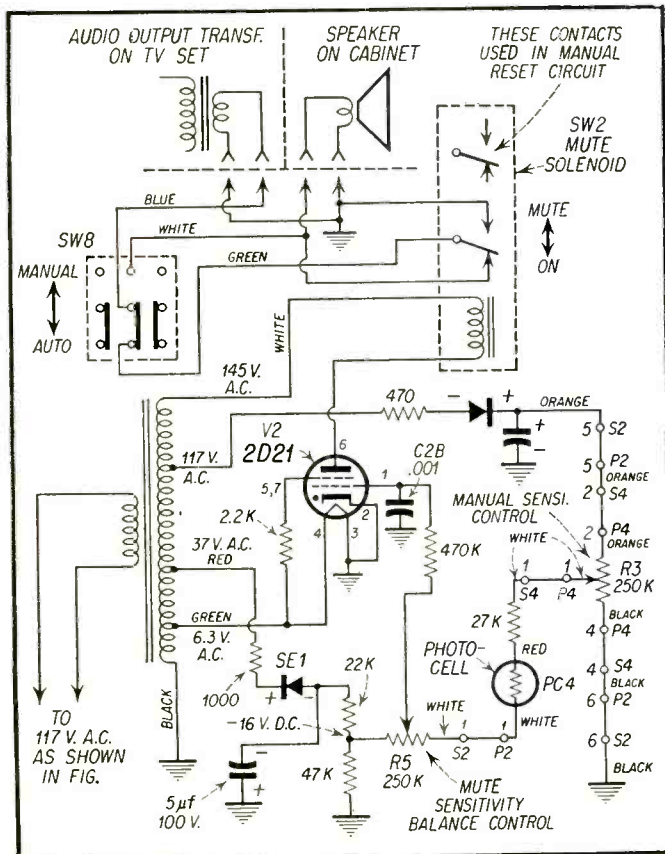

Fig. 3—Partial schematic of CCW motor control.

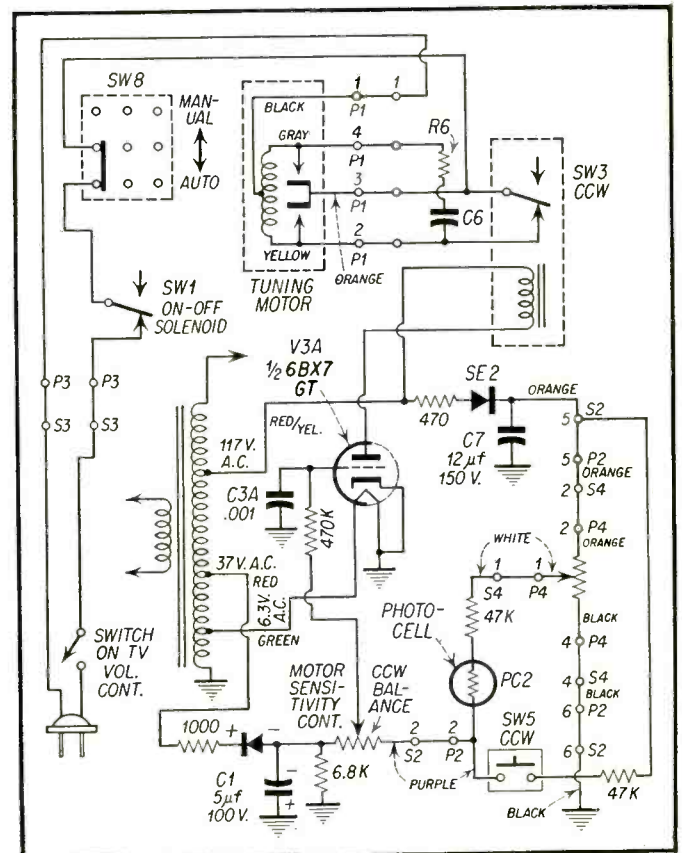

Fig. 4—Partial schematic of Mute control circuit.

circuit increases and grid voltage is raised above cut-off as described above. V1 then conducts and activates the solenoid in the plate circuit.

### Switching Circuit

Figure 2 shows the switch in the "ON" position. Following the circuit through shows that in this position the circuit from the primary of TV receiver power transformer to the ac line is closed. The next time the solenoid is actuated by light falling on PC 1, the contacts of SW1 open, thus opening the ac line to the power transformer.

The extra set of contacts shown on

the diagram are involved with the manual re-set circuit which is not shown here. This circuit enables the user to reset the position of the contacts on SW-1 by means of a switch on the front panel, without having to resort to a light beam.

### MUTE CONTROL CIRCUIT

Figure 3 is a partial schematic of the "Mute" control circuit. This circuit enables the viewer to silence the sound at his convenience. A comparison of Fig. 3 with Fig. 2 will show an exact similarity of circuitry except for the circuits tied to the solenoid switches. From this

it follows that the circuit explanation given for the "ON-OFF" control circuit applies in this case as well. As can be seen by the pin, plug, and socket numbers, the manual sensitivity control circuit is common to both the "ON-OFF" and the "MUTE" control circuits. Actually, as will be seen later, it is common to all the control circuits.

The switching circuit is a fairly simple arrangement. In the "on" position shown in Fig. 3, the secondary of the audio output transformer is connected through the switch contacts to the speaker voice coil. In the "mute" position, the output transformer secondary is shorted. The second set of contact points, as with the "ON-OFF" circuit, are concerned with manual re-set of the mute contacts.

### MOTOR CONTROL CIRCUIT

Figure 4 is the partial schematic showing the motor control circuit for counter clockwise rotation of the tuner. Let us first examine the motor unit itself. This is an induction type motor with two windings. As seen in the figure one of these windings is between terminals 1 and 4 of the motor plug and the other between terminals 1 and 2. One side of the ac line is permanently connected to the common terminal, No. 1. If the other side of the line is connected to terminal 2, the motor rotates in a counter clockwise direction, while clockwise rotation is produced if the connection is made to terminal 4.

SW-3 is an ordinary plate circuit relay, actuated by the plate current of V3A. The control circuit itself is very similar to the "on-off" control circuit. The same explanation given previously for the action of the photocell in controlling the tube bias holds in this case also. An important difference is that plate relay switch makes only momentary contact. It releases as soon as the light beam is removed from the photocell. The current requirements for this operation are much less than that required for the solenoids. For this reason an ordinary low current triode may be used for control rather than the thyatron.

### Homing Action

When the relay is actuated, the contacts of SW-3 close, and the motor begins to turn in a counter clockwise direction. The motor is geared to turret tuner. Fig. 5 is a photograph of the drive motor assembly and will help in understanding the action which takes place. The index cam actuates the switch trip latch which closes a set of contacts (Switch assembly S-23294). These contacts are wired in parallel [Continued on page 42]

## Your Profit Starts The Very First Day

**TEST and REPAIR TV PICTURE TUBES**

### NEW DELUXE CRT 400 with 4½" Plastic Meter

This portable Cathode Rejuvenator Tester quickly locates and corrects picture tube troubles in a few minutes, right in the home, without removing tube from set! Restores emission, stops leakage, repairs inter-element shorts and open circuits. Life-test checks gas content and predicts remaining useful tube life. Grid Cut-Off reading indicates picture quality customer can expect. Earns servicing dollars in minutes. Cuts operating costs, eliminates tube transportation. Saves money on TV set trade-in reconditioning. Pays its way from the very first day.

Weights only 5 lbs. mounted in rugged, luggage style, carrying case covered with handsome, durable leatherette. Size: 11 x 7½ x 5".

Model 400. Net \$5495



Over 20,000 CRT'S NOW IN DAILY USE ACROSS THE NATION



### NEW ECONOMY CRT 200

A quick profit maker priced low enough for every serviceman to cash in on picture tube repairs. Performs most of the functions of the CRT 400. Has 3" meter. In leatherette carrying case. Size: 11 x 7½ x 5". Weighs 5 lbs.

Model 200. Net \$3995



Send for Bulletin 104-D

**B & K MANUFACTURING CO.**  
3726 N. Southport Ave. • Chicago 13, Illinois





**FIRST** TO BREAK THE TV RECEPTION BARRIER...

**MOST POWERFUL SUPER FRINGE  
ANTENNA IN THE WORLD**

# NEW WALSCO WIZARD

with exclusive **PHASE REVERSER**

Distance is no barrier to the amazing new WALSCO WIZARD. Exclusive "Phase Reverser" delivers the sharpest, crystal-clear picture ever seen in the most difficult reception areas. No other antenna like it!

New WIZARD offers highest gain and sharpest directivity possible on all VHF channels. Installation in a jiffy... without complicated harnesses, phasing stubs, or extra dipoles. Guaranteed for 3 years!



**ELECTRONICS CORPORATION**

A SUBSIDIARY OF Tektronix CORPORATION

3502 Crenshaw Blvd.,  
Los Angeles 16, California

Model  
Wizardette #4210  
Wizard #4220  
Wizard Imperial #4230

Price  
\$14.90 list  
19.50 list  
34.90 list

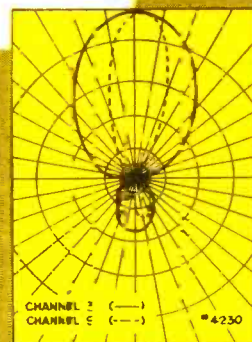

WALSCO WIZARD Imperial equals reception of 10 element yagis on low channels, and equals a three stack 10 element (30 elements) yagi on channels 7 to 13

Actual comparison of fringe antenna performance

Channels	Gain (db) Single Bay							
	2	4	6	7	9	11	13	
Walseo Wizard Imperial	6.1	6.3	8.2	11.9	11.6	10.8	12.6	
Antenna "A" With 3 Phase Reversing Dipoles	6.3	6.6	8.1	10.5	10.2	10.6	12.4	
Antenna "B" Yagi Type with Phasing Loops	5.1	5.5	6.8	7.5	9.6	8.8	11.2	
Antenna "C" Yagi Type with Loading Coils	5.9	6.9	8.6	9.1	8.6	9.6	7.8	

# COLOR SYNC ANALYSIS

## Discussion Of Burst Gate Operation In Color TV Receivers

### PART 2

by **Bob Dargan and Sam Marshall**

from a forthcoming book entitled "Fundamentals of Color Television"

**I**N the previous installment we established the functions of the various sections that make up the Color Sync system. These sections consist of the Burst Gate, Phase Detector, Reactance Tube, Local 3.58 MC Oscillator, and Quadrature Amplifier Circuits. We may now proceed to a discussion of the basic circuits employed in each of these sections.

#### Burst Gate

As outlined in previous discussions, the purpose of the Burst Gate circuit is to make available a pure color burst signal, devoid of other signals, to the input terminals of the Phase Detector. A basic block diagram illustrating this action is shown in Fig. 1. Here, in one type of receiver, we observe that the composite signal enters the Burst Gate circuit from one end via a 3.58 mc resonant circuit. The phase of this signal with reference to the sampled sub-carrier (color burst) is advanced  $33^\circ$  if the receiver is an I/Q type. In an R-Y/B-Y receiver no change in phase is given the signal because its phase is initially correct for demodulation of the chroma signal.

Entering the Burst Gate circuit from the other end is a flyback pulse signal from the horizontal output transformer which drives the Burst Gate tube into conduction. In some receivers this signal is a trifle delayed (as shown by the waveforms at the left side of the figure) so that it reaches the Burst Gate immediately following the horizontal sync pulse. The timing of the delayed flyback pulse now coincides with the color burst signal. Thus, it is seen that the purpose of the Flyback Pulse Delay Network is to synchronize the timing of the flyback pulse with the color burst at the Burst Gate. Where the gating pulse is broad

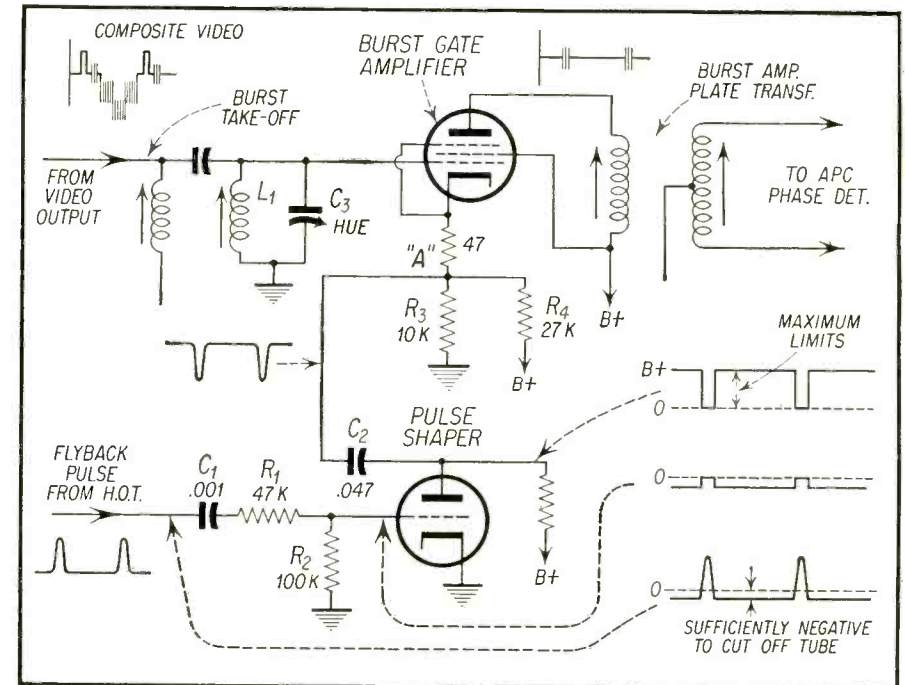

Fig. 2—Simplified schematic of burst gate circuit in CBS I/Q color receiver chassis.

enough to accommodate the horizontal sync pulse and burst gate signal a delay network is not used.

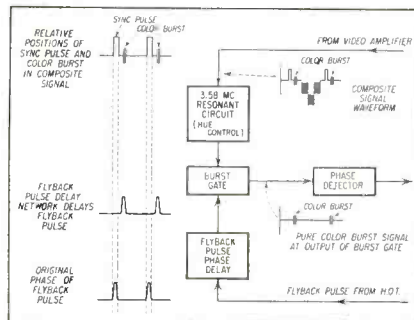

Fig. 1—Functional block diagram of burst gate action in providing pure color burst signal at output of burst gate. Where flyback pulse is broad enough to include horizontal sync and burst signals no phase delay network is needed.

#### Burst Gate Circuits—CBS

A simplified version of a commercial I/Q Burst Gate circuit is shown in Fig. 2. Here a composite video signal is fed into a burst takeoff coil and into the 3.58 mc parallel resonant circuit comprising  $L_1$  and  $C_3$ . Hue Control  $C_3$  is adjusted to provide the necessary  $33^\circ$  phase advance to the color burst signal which is fed into the Burst Amplifier. As indicated in previous discussions, correct adjustment of this control is made by the operator when he adjusts it for correct color balance against reference colors such as flesh tones, etc. Although in an R-Y/B-Y receiver this phase shift is not required, a hue control is nevertheless employed to correct for chroma signal phase shift in previous chroma circuits, this control being located in the input to the Burst Gate amplifier or in the Phase Detector circuit.

The manner in which a signal may



be made to undergo a phase shift is shown in Fig. 3. In Fig. 3A we observe a signal of a given frequency entering a tuned parallel resonant circuit. In Fig. 3B is shown the manner in which the phase of the output signal is affected as the circuit is tuned in either direction away from resonance.

At resonance, the phase shift is zero. Below resonance the outgoing signal phase may be made to lead the incoming signal by as much as 90°. Above resonance the outgoing signal may be made to lag the incoming signal by the same amount. In effecting this phase shift, the circuit impedance, and hence the signal amplitude is gradually reduced. However, this phase shift may be as high as 45° in either direction without seriously affecting the signal amplitude.

Returning again to an analysis of Fig. 2, the Burst Gate tube is initially biased to cutoff by the negative grid-to-cathode voltage developed across the voltage divider R3 and R4. This circuit contains a tube called a Pulse Shaper which provides a flyback pulse of proper shape and polarity to the cathode of the Burst Gate Amplifier. It is only when a high amplitude negative-going flyback pulse from the Pulse Shaper is present to cancel the positive voltage across R3 that the Burst Gate tube conducts.

The pulse shaping network consists of C1, R1 and R2. This network clips the flyback at the base as shown at the right. In this receiver the flyback pulse is broad enough to accommodate the sync and burst signals so that the color

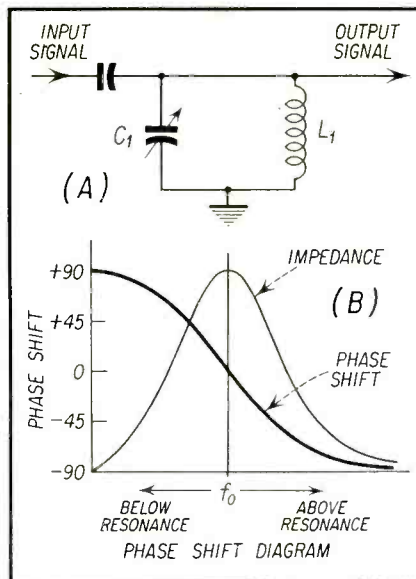

Fig. 3—In (A) we see the signal entering and leaving a parallel resonant circuit. In (B) we observe the phase shift that occurs in a parallel resonant circuit as the circuit is detuned above and below resonance. Above resonance the phase shift is negative. Below resonance the phase shift is positive.

burst appears in the plate circuit of the Burst Amplifier. Connected in this plate circuit is a transformer which feeds the reference burst phase signal to the phase detector.

To summarize the action taking place in this circuit:

1. A delayed positive flyback pulse

is applied to the grid of the Pulse Shaper.

2. A negative flyback pulse appearing in the plate circuit of the Pulse Shaper is applied to the cathode of the Burst Amplifier.

3. The Burst Amplifier is triggered into conduction at the same instant that the color burst signal appears in the composite video signal.

4. The plate circuit of the Burst Amplifier contains only the color burst signal advanced 33° in phase, the latter being fed into the phase detector transformer.

### Burst Gate Circuit—Motorola

A Burst Gate circuit used in an R-Y/B-Y receiver is shown in Fig. 4. Here we observe that the flyback pulse is delayed through the network comprising R1, R2 and C1, and is fed a positive pulse into the screen grid of the Burst Amplifier. As a result of this pulse the Burst Amplifier is driven into conduction simultaneously with the appearance of the color burst in the composite signal.

The color burst signal is taken off the bandpass amplifier transformer and is fed into the Burst Gate Amplifier grid via the Burst Takeoff coil. Across this coil we find C2 the Hue Control which in combination with L1 is resonant at 3.58 mc. In this case being employed in an R-Y/B-Y receiver the Hue Control merely corrects for any phase shift of the color burst signal in previous chroma circuits, and thereby provides an exact subcarrier reference

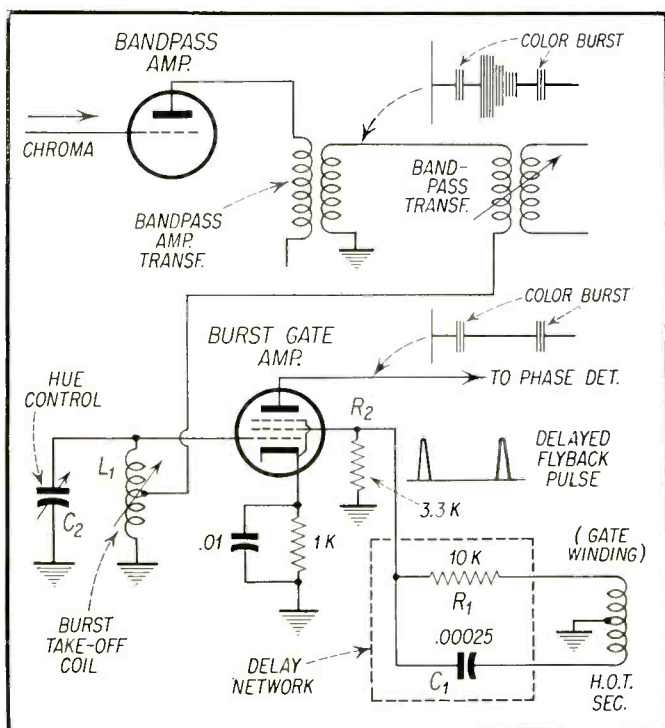

Fig. 4—Simplified schematic of burst gate circuit used in Motorola R-Y/B-Y color receiver.

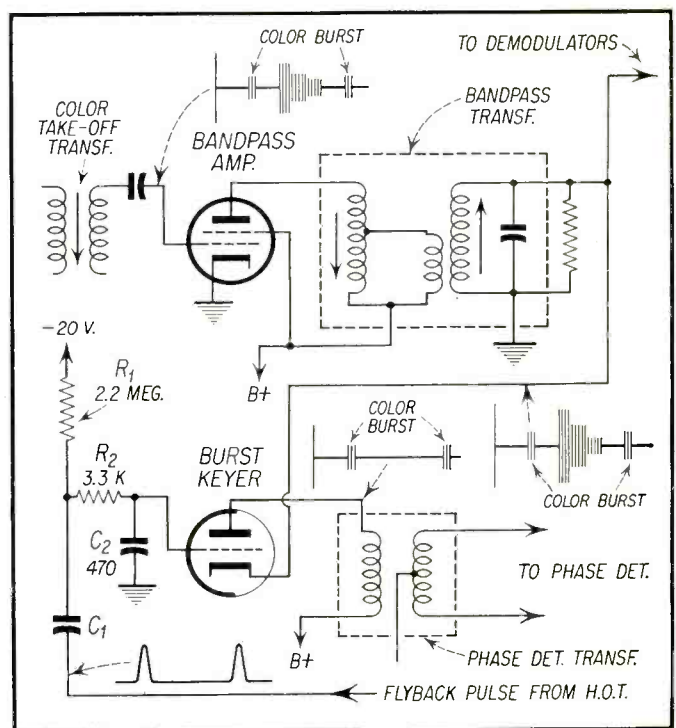

Fig. 5—Simplified burst keyer (burst gate) circuit used in RCA 21CT662U color receiver.

phase color burst signal to the phase detector.

### Burst Gate Circuit—RCA

In Fig. 5 we illustrate a third type of Burst Gate circuit. Here the Burst Kever tube is biased -20 volts to cutoff, being returned to the -20 volt buss via R1. The positive flyback voltage pulse from the horizontal output transformer via C1 is sufficient to overcome this bias and drive the Burst Kever tube into conduction. As in previous circuits a time delay network R2-C2 provides tube conduction only during the time of the color burst. The latter is fed into the cathode of the Burst Kever from the Band Pass Transformer. Thus, the signal appearing in the plate circuit of the Kever tube consists of the color burst signal exclusively, and as such is fed into the Phase Detector Transformer.

### Color Burst Circuit—Emerson

A fourth circuit, employing a diode burst gate tube is shown in Fig. 6. Here the chroma signal is fed into the Burst Takeoff coil via the primary return of the Demodulator Transformer. This being an R-Y/B-Y receiver no phase shift is given the color burst signal. However, phase shift of the signal which takes place in the components of the previous chroma circuits must be corrected for. This is done by means of the Hue Control which in conjunction with the Burst Takeoff coil forms a 3.58 mc parallel resonant circuit.

To understand the operation of the

circuit shown in Fig. 6 we must first understand how the flyback pulse is developed and fed back to the cathode of the burst gate diode via the 220 ohm resistor. Notice that this flyback pulse is the sum of the voltages across two oppositely phased windings (A) and (B) on the horizontal output transformer. Winding (A) develops a 260 volt peak to peak pulse, and winding (B) develops a 115 volt peak to peak pulse 180° out of phase with winding (A). The peak to peak voltage of the pulse takeoff point Y with respect to ground is thus  $260 - 115 = 145$  volts.

The voltage waveform across windings (A) and (B) follows the pattern of the conventional waveforms found in a horizontal output transformer secondary but on a somewhat reduced scale. During the trace period represented by (b) in waveform at Y the induced voltage at the terminal Y of the transformer is negative by about 15 volts with respect to terminal X. During retrace however this voltage goes sharply positive by 145 V. Thus, during sweep, the cathode is -15 volts with respect to ground, and during retrace it is +130 volts with respect to ground.

Notice that the plate of the diode is effectively grounded through the burst takeoff coil. Thus, during sweep, when the cathode is negative with respect to plate the tube conducts. During retrace however the cathode is positive with respect to plate and the tube is cut off.

We may now consider the diode as an electronic switch. During retrace it does not conduct and represents the

switch open. During sweep the diode conducts and represents the switch closed.

Referring again to Fig. 6 we observe that this switch is effectively connected across the Burst Takeoff coil via C1. During retrace, the switch is open and the chroma signal is developed across the Burst Takeoff coil from whence the burst signal continues on to the Phase Detector. During sweep, however, the switch is closed and the chroma signal is shorted to ground.

During the latter period it becomes necessary to provide a substantial load to the horizontal output transformer windings. This is taken care of by the 220 ohm resistor in the cathode leg of the diode.

It will be recalled that one of the functions common to the burst gate circuits under consideration is the delay given the flyback pulse so that the Burst Gate tube conducts in time coincidence with the color burst signal. This circuit differs from the previous circuit discussed in that the time delay is effected in another section of the receiver. The following block diagram analysis show how this is done.

Referring to Fig. 7 we observe that the composite if signal is fed into two detectors, one detector being in the luminance channel and the other in the chrominance channel. The output of the luminance amplifier (A) contains the sync and luminance signals. These are fed into the sync separator the output of which (B) contains only the

[Continued on page 46]

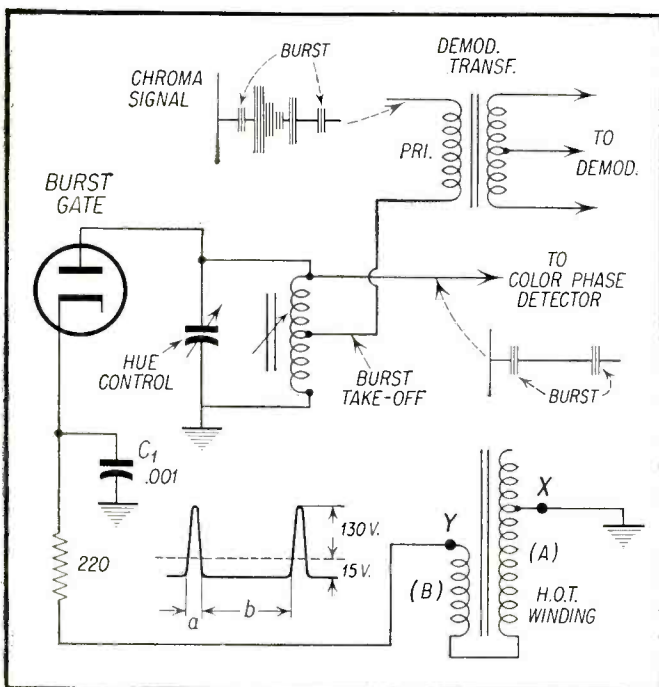

Fig. 6—Simplified schematic of burst gate circuit employed in Emerson R-Y/B-Y receiver.

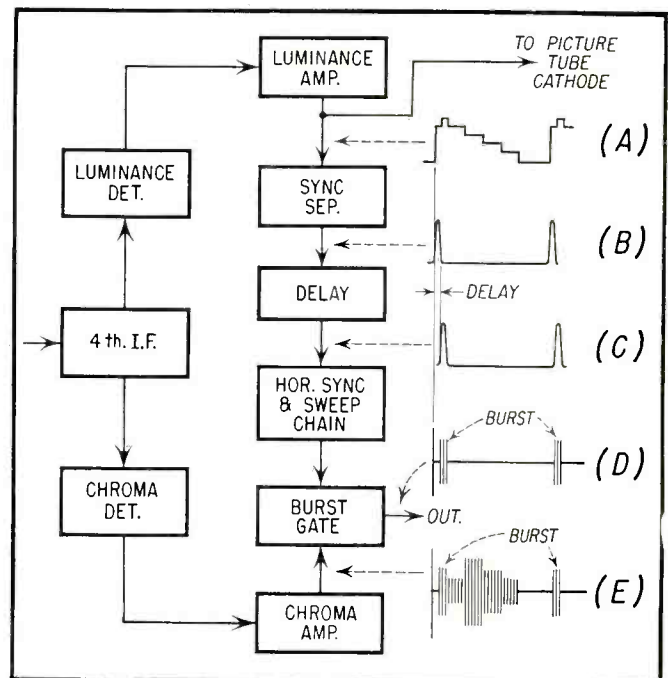

Fig. 7—Sync signal delay in horizontal sync and sweep chain produces burst signal in output.



# THE WORK BENCH

## Unusual Service Problems And Their Solutions

by Paul Goldberg

### This Month's Problems:

**Unusual tube trouble**  
**Sound bars in pix**  
**Insufficient vertical sweep**

#### Admiral 22A2

The receiver was turned on and an accompanying whistle was heard from the speaker with the normal audio, but no interference was observed in the picture. This was not the usual tuner howl but of a higher frequency. All the audio tubes were replaced individually but had no effect. The 6V6 and the 6BQ7, tuner oscillator and RF tubes were replaced individually but had no effect. The diagram was then studied. Because there was no interference in the picture it was thought that the oscillation might be caused by the proximity of some wires in the audio circuitry. All the audio wires and components were then pushed and probed and tapped but to no avail. See Fig. 1.

While tapping the audio output tube 6V6, the high voltage anode cap was accidentally pushed out of its hole in the C.R.T. (the anode cap is physically directly above the 6V6). When this was done amazingly enough, although there was no raster, there was also no whistle heard from the speaker. Many high frequency whistles are caused by loose connections in the high voltage transformer but usually these whistles are not heard from the speaker but are heard directly from the H.V. transformer.

As a positive check the 6SN7 horizontal oscillator was removed from its socket and the receiver was turned on. No whistle was heard from the speaker. The whistle was thus definitely caused by something in the high voltage supply. The 6SN7 horizontal oscillator, 6CD6 and 6W4 were replaced individually but had no effect. The old trick of tightening up the screws holding the high voltage transformer together was attempted but to no avail. Hopelessly, the 1B3, high voltage rectifier was replaced and to our surprise the whistle stopped. Checking the old 1B3 visually, we assumed that somehow this tube was oscillating internally, either because of a microscopic air hole or a loose element. Whatever it was, the receiver now

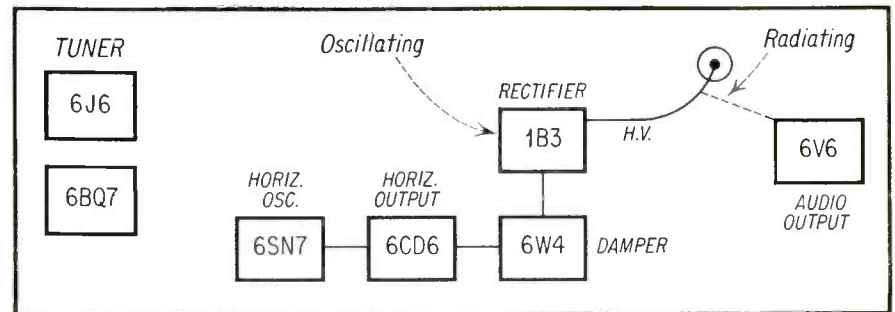

Fig. 1—Partial schematic of Admiral 22A2

functioned normally. (The anode lead and H. V. cap, being physically close to the 6V6, acted as the radiating element.)

#### General Electric—21T7

The receiver was turned on and it was observed that sound bars were in the picture. The volume control was turned from minimum to maximum to check whether increased volume caused greater sound bar intensity. However, adjusting the volume control seemed to have very little effect. As a positive check, the speaker was disconnected and a 5 ohm resistor was substituted in its place. Nevertheless, sound bars appeared in the picture again. We had

now eliminated the microphonic effect as the cause of the trouble. Also, because an increase in volume did not cause greater sound bar intensity the filters seemed improbable as a cause of the trouble.

Knowing these facts the picture quality was carefully examined. It was noticed now that a slight herring bone pattern appeared in the picture. This indicates in many cases a misalignment of one of the sound traps (which could cause the sound bar trouble). L151, part of the 41.25 megacycle if sound carrier trap, was aligned for minimum herring bone in the picture. This solved our problem as the sound bars were

[Continued on page 43]

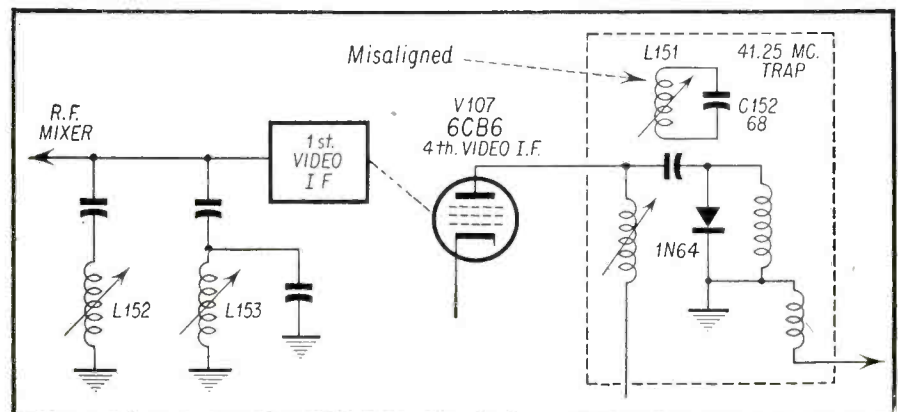

Fig. 2—Partial schematic of General Electric 21T7

# The Dyna-Quik Tube

A New Tube Tester Designed For Rapid And

by **Engineering Dept.**  
B & K Mfg. Co.

**T**HE DYNA-QUIK Model 500 Tube Tester checks more than 300 of the tubes most widely used in television and radio receivers. It checks these tubes in a very short time because it has relatively few controls. This tester also checks tubes for their Dynamic Mutual Conductance ( $G_m$ ) in a true trans-conductance bridge. Diodes are checked for emission only, since they possess no mutual conductance. Each tube is automatically checked for short circuits and leakage up to 1 megohm. These tests are made between heater and cathode, grid and cathode, grid and plate, and screen grid and plate. This test is made before the  $G_m$  measurement. Gas, grid contamination, or even obscure grid-to-cathode leakage are all disclosed by an exceptionally sensitive grid current check. This test will reveal as little as 2 microamperes of current in the grid circuit.

## Testing Tubes For Dynamic Mutual Conductance

In radio and television circuits practically all tubes (except for rectifiers and diodes) are used as some type of amplifier. Even oscillator circuits (i.e.—R.F. or horizontal oscillators) are just basically amplifiers with regenerative feedback. Therefore, the most important characteristic to be checked to determine how effectively any radio and TV tube will function in its circuit, is its amplification.

The Mutual Conductance is the ratio of the change in plate current that results from a small change in grid voltage.

$$G_m = \frac{\Delta I_p}{\Delta E_g}$$

where:

$\Delta I_p$  = a small change in plate signal current.

$\Delta E_g$  = a small change in grid signal voltage.

The amplification of a circuit is  $= G_m R_L$ , where  $R_L$  is the equivalent load resistance of the stage. Since  $R_L$  is constant in any circuit, we see that the amplification depends directly on the  $G_m$  of the tube. The  $G_m$  for a given tube can be measured accurately if a small given *ac* signal voltage is applied to the grid and the resultant *ac* plate current measured. This is done by means of a sensitive bridge circuit. Measuring the mutual conductance of a tube provides the most accurate and all inclusive test that can be made on any tube.

## Testing Double Triodes And Other Multiple Tubes

In order to quickly test double triodes and other dual tubes, the Mutual Conductance of the two halves of the tube

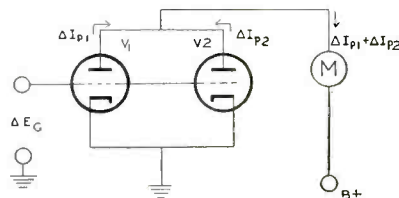

Fig. 1—Measuring  $G_m$  of dual triode tubes.

in parallel is measured. In Fig. 1, we see that if the same signal voltage  $\Delta E_g$  is applied to the grid of  $V_1$  and  $V_2$  in parallel, the resultant plate current change measured by the meter will be the sum of the  $\Delta I_p$  of each tube.

$$G_m (V_1 + V_2) = \frac{\Delta I_{p1}}{\Delta E_{g1}} + \frac{\Delta I_{p2}}{\Delta E_{g2}}$$

$$\text{Since } \Delta E_{g1} = \Delta E_{g2}$$

$$\text{Therefore: } G_m (V_1 + V_2) =$$

$$\frac{\Delta I_{p1} + \Delta I_{p2}}{\Delta E_{g1}}$$

then the  $G_m$  reading for the tubes in parallel is the sum of the  $G_m$  for each tube.

If either tube is down in  $G_m$  then the sum will be low, and the tube

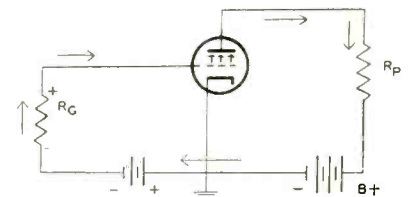

Fig. 2—How negative grid current is developed in a tube.

should be rejected. This way multiple tubes are automatically set up and tested in the DYNA-QUIK with one fast and accurate check.

## Life Test

Many manufacturers have found that testing tubes under reduced heater voltage conditions will give a strong indication of its probably useful life. A tube may show adequate  $G_m$  under normal test conditions; however, a reduction of 10% to 15% of heater voltage may be marked by a sharp slump in  $G_m$  reading. This slump or decay indicates that the space charge of the tube has been depleted to the point where the tube will have a short remaining useful life. While the amount of life remaining cannot be too closely estimated, you can be reasonably sure that a tube showing a sharp slump is not a good risk for continued trouble-free service.

## Testing Tubes For Grid Emission Or Gas

The Grid Emission or Gas Test is an invaluable aid in TV servicing because it quickly picks out those tubes which can cause trouble in *agc* sync, *if* amplifier, and *rf* tuner circuits. In order to understand how a tube can have "grid

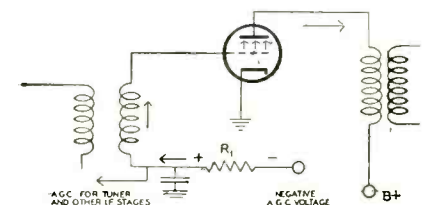

Fig. 3—Effect of negative grid current in a typical IF stage.



# Tester

## Effective Tube Checking



Fig. 4—Waveform of normal video and sync signal.

emission" and "negative grid current" we must look into the theory of electron tubes.

There is normally some little evaporation of the cathode coating remaining in a tube. Some of this vapor tends to deposit on the grid and causes what is known as "grid emission." Where the grid itself emits electrons the plate draws current commonly known as "negative grid current."

The flow of this "negative grid current" can be followed in Fig. 2. The electrons flow from the grid to the plate then back through the power supply to the grid leak resistor  $R_g$  and up to the grid again. Notice that the voltage drop across the grid leak resistor  $R_g$  is such that it causes the grid to go more positive than it normally would with no grid emission.

If a slight amount of "gas" is present in a tube some of the electrons from the cathode will collide with molecules of the gas and may knock off one or more electrons leaving positive ions (ionization). Some of these positive ions may then strike the grid, taking an electron from the grid to form a gas molecule again. When this molecule is ionized again, the electron taken from the grid is released and goes to the plate. The electron flow of this "gas current" is exactly the same as it is for the "grid emission current" and can be traced on Fig. 2. Notice again that the grid is made more positive by this "gas current."

Now let us see what happens if an amplifier tube in a TV set has grid



Fig. 5—Overloaded or clipped video and sync signal.

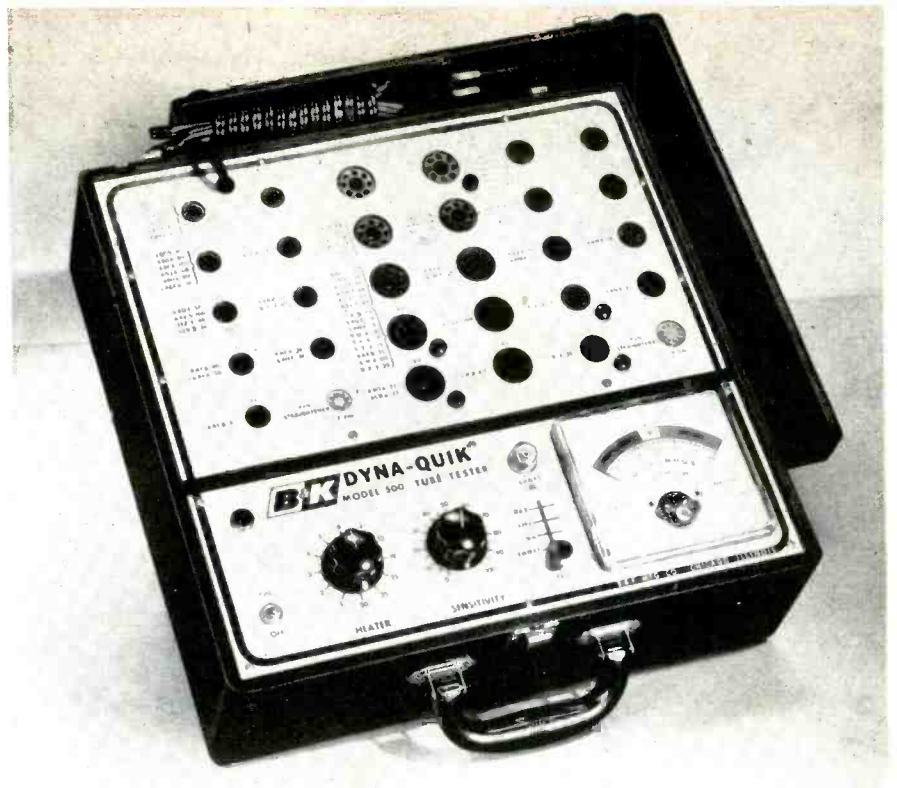

Panel view of Dyna-Quik tube tester showing tube numbers clearly visible on front panel. Obsolescence is eliminated by availability of new overlay panels.

emission current or gas current (negative grid current). In Fig. 2 we noted that the grid would tend to go more positive if negative grid current flowed.

In Fig. 3, a typical *if* stage, we see that if there is any negative grid current, the bias voltage in that stage and

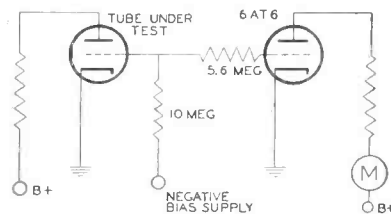

Fig. 6—Grid emission test circuit used in Dyna-Quik tester.

other associated stages will go more positive because of the flow of current through  $R_l$ . Making the grid more positive will drive the tubes to saturation, causing clipping or overloading.

After detection, a video signal normally appears as shown in Fig. 4. If the signal is clipped in an *if* stage it will look like Fig. 5. Now the horizontal oscillator will try to synchronize both on the blanking signal (A) and on the very black portions of the video (B). This results in pulling or shaking of the picture. To achieve this sensitive grid emission or gas test, the circuit shown in Fig. 6 was employed.

The tube under test has its normal plate voltage applied, but the grid is biased beyond cut-off so that no plate

current flows. This bias is applied through the 10 megohm resistor. The same 10 megohm resistor is also in the grid circuit of a 6AT6 d.c. amplifier and the conditions in this tube are such that it, too, is biased just beyond cut-off. Under these conditions, no plate current flows in the 6AT6 and no reading is obtained on the meter in its plate circuit.

However, if the tube under test is gaseous, or its grid is contaminated with some of the cathode coating, then current will flow from grid to plate and through the 10 meg resistor back to the grid again. This will produce a positive voltage drop across the 10 meg resistor, lifting the cut-off bias on the 6AT6 and producing a meter deflection. Upon seeing this deflection, the technician immediately knows that the test tube is defective and a replacement is indicated.

### Automatic Line Voltage Compensation

Every effort has been made to make the operation of this instrument as fast and simple as possible. Toward this end, automatic line voltage compensation has been incorporated into the tester. A voltage sensitive bridge monitors the line voltage at all times and automatically adjusts the sensitivity of the  $G_m$  bridge to compensate for these line voltage variations. This eliminates the necessity of readjusting the line voltage for different types of tubes and at different line voltages.

# More Professional Servicemen Subscribe To "SERVICE DEALER" Than Any Other Technical Magazine Because Its Feature Articles and Regular Departments Have Proven To Be The Most Helpful, Accurate and Timely. 24 Issues Cost Only \$2.

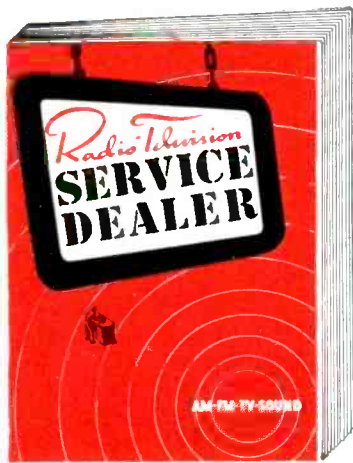

*You may subscribe if you are a:*

- \* Serviceman employed by a Service Organization.
- \* Serviceman employed by a radio/TV Dealer.
- \* Serviceman employed in industrial electronic service firms.
- \* Independent serviceman who does not have a business establishment.
- \* Employee of a Distributor.
- \* Student enrolled in accredited Radio/TV Schools, Colleges, etc.
- \* Hobbyists or experimenter.

## A TYPICAL ISSUE COVERS

- Video Speed Servicing Systems
- Rider's "TV Field Service Manual" data sheets
- Latest TV Installation and Maintenance Techniques for VHF and UHF
- Auto Radio Installation and Service
- Advanced Data on New Circuitry
- Production Changes and field service data on receivers
- New Tubes
- New Test Equipment, operation and application
- Hi-Fi Installation and service
- New developments, such as transistors, color, UHF, etc.
- News of the trade
- Service Short Cuts & Shop Notes
- Explanation of difficult circuits

**"Service Dealer" does not have field subscription salesmen calling on the trade.**

**You must order your subscription direct from us or from your magazine agency.**

**Subscription rates: \$2.00 for 2 years      \$1.00 for 1 year**

RADIO-TV SERVICE DEALER  
67 W. 44 St., New York 36, N.Y.

NEW     RENEWAL

Gentlemen: Here is \$2.00 for which enter my 2 year subscription. (This rate applies in USA only. Elsewhere add \$1 per year)

Name .....

Address .....

City ..... Zone ..... State .....

Name of firm .....  Owner .....  Employee .....

Firm's business address.....

City ..... Zone ..... State .....

Your Position or Title.....

Check whether firm is:  Service Organization or  Dealer having Service Dept.

If some other type of company describe:.....

IF STUDENT, Name of School.....



# PROBEMETER

## A Signal Tracing Absorption Meter Designed For Trouble-Shooting Radio and TV Receivers

by **Engineering Staff**  
Research Inventions  
& Mfg. Co.

THE "Probe Meter" is a broadly tuned probe and absorption meter designed to trace signals thru a T.V. or radio, from above or below chassis. No connecting or extension wires are necessary when tracing signals; however, if greater sensitivity is desired or when measuring voltage, the plug-in ground return wire is used. A convenient pin jack outlet is provided for use with a scope or phones.

Externally, the "Probe Meter" is a combined probe, meter, tuning, and attenuation control. The possible positions of the control are labeled OSC., IF, RF, VIDEO, HZ. SWP., ARC., AUDIO., an attenuation range and 500 V.D.C.

### Circuit

Internally, the "Video Probe Meter" utilizes a broadly tuned circuit (See Fig. 1) using a high efficiency ger-

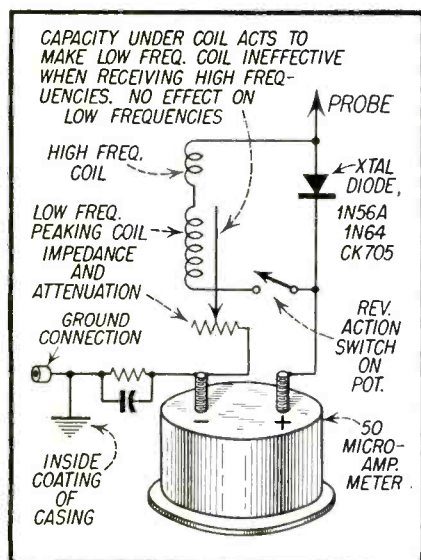

Fig. 1—Functional schematic of internal connections of Probemeter. 50 microamp. meter is used.

manium diode for detection. The coil is so tuned that it encompasses directly and harmonically with most general frequencies associated with a TV or radio. The circuit is a double tuned series arrangement containing a high and a low frequency coil. The high frequency coil responds generally to megacycles; and the low frequency coil absorbs energy in the kilocycle and lower megacycle range, and also acts as a peaking coil.

Broad tuning or selection is accomplished with a  $\frac{3}{4}$  meg. potentiometer. With this control the impedance of the circuit can be varied and signals can be attenuated. With the use of this potentiometer, extremes of frequencies can easily be selected. Direct contact to a "live" circuit forces a signal into the meter and increases the broad band characteristics of the probe (by-passing the tuned effect), thus enabling attenuation with the same impedance control. The coil is wound so that its fundamental and harmonic reception is greatest (more sensitive) to wanted TV frequencies. (IF's 22mc, 44 mc.)

The 500 V.D.C. scale can be used conveniently when testing for *dc* voltages. (20,000 ohms/Volt.)

### Signal Tracing

When tracing signals above chassis (in the home), the pick-up loop or ring is slid over each succeeding *if* or video amplifier tube. In a weak signal area, the strongest channel is used and the oscillator fine tuning on TV is adjusted for maximum reading. When tubes are shielded, the tube shield is loosened from chassis ground and the probe is touched to shield to obtain a reading.

Where internally shielded tubes are encountered, such as the 6AU6, the pick-up loop is slid to the extreme bottom of tube. If a strong signal is available, radiation can be detected from the second or third *if* stage; however, it is usually difficult to detect a signal thru internally shielded tubes. An interesting feature of the pick-up loop is that it is flexible and expandable and can be used on tubes of various sizes. Where it is difficult to detect radiation or signal



Fig. 2—Actual photo of Probemeter illustrates ease with which it may be applied to circuits being tested. Complete unit is shielded.

from a tube, the tube is removed and the probe inserted directly into grid pin of the socket. It is not necessary to know which pin is the grid; if a signal is present the meter can determine that. All pins are tried until needle deflection is observed. This pin will be the grid. By the same process it is very easy to locate the grid circuit (input) and plate circuit (output) on tubes of which the pin connections are unfamiliar.

This *if* probe and absorption meter is basically designed to select and differentiate between *high frequencies* (above 1 megacycle) and *low frequencies* (below 1 megacycle). The positioning of the indicator knob selects the two basic settings.

The probe is selective to the higher frequencies when the indicator knob is turned to the extreme *clockwise position* (VIDEO, OSC. IF, RF.). These frequencies (above 1 megacycle) include the carrier, local oscillator, *if*, video, sound *if*.

The meter will receive low frequencies (kilocycles) when the indicator knob is in *any other position* (except the high frequency position) including the attenuate position. However, the greatest sensitivity or selectivity to low frequencies is in the adjacent range, labeled (VIDEO, HZ. SWP., ARC.). This position is used for testing low frequency content of video, horizontal

[Continued on page 44]

# NEW COMPONENTS

In requesting more detailed information on these products, please write the code number of the product on a postcard and send it, along with your company letterhead or business card, to New Products Dept., SERVICE DEALER, Suite 510, 67 West 44th St., New York 36, N.Y.

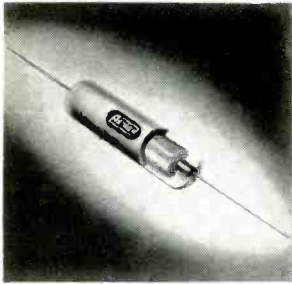

## Astron Capacitors

The Astron Corporation's Blue Point Capacitor utilizes an advance-type thermosetting impregnant which exhibits high capacitance stability, low power factor and high insulation resistance over its temperature range of  $-40^{\circ}\text{C}$  to  $+85^{\circ}\text{C}$ . The unit is small, has excellent resistance to vibration and shock, withstands continuous  $85^{\circ}\text{C}$  operation without derating, and has extra clear marking for ease of identification and installation and wide range of values. For data, check C19.



## Mall Kit

A home economy kit, featuring 22 pieces, has been announced by the Mall Tool Co. Specifications of the Model 149B Drill are: Capacity, 1/4" steel and 1/2" wood; motor, ac-dc, 25 to 60 cycle; chuck, geared key type; voltage rating, 2.3 amps; bearings, ball and bronze oilite; free speed, 2500 RPM; load speed, 1500 RPM; length 8" overall; net weight, 3 lbs., equipped with 7 ft. cord, plug and ground. Included in this 22-piece kit are: geared chuck drive; pedestal; 9 drill bits; a 5" rubber backing pad; 6" polishing pad; six abrasive discs; paint stirrer; side handle and steel carrying case. For data, check C13.

## Airport Pin Locator

Airport Television and Radio Co. has developed a simplified vacuum tube computer, the Quick-Way Tube Pin Locator, which determines what each tube pin signifies at the socket base. The unit operates with a turn of the dial, covers hundreds of receiving tube types. When set to tube number, it selects all pin locations. A new tube log imprinted on the face eliminates obsolescence. For data, check C12.

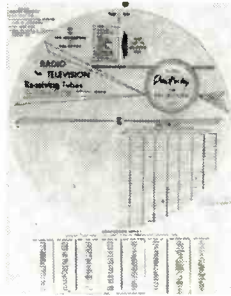

## Stackbin Shelves

Sectional Stackshelves are individual shelf units that stack and interlock without tools or bolts. Each Sectional Stackshelf can be easily arranged and rearranged to suit user's convenience. Stackshelves are made of heavy gauge sheet steel with a baked-on enamel finish, have an all welded construction for long life. Individual Stackshelves can be made in a variety of depths and heights. Widths are standard 37" so that units of varying depths and heights can be stacked to fit user's requirements. For further data, check C15.



## G-C Phono Drive Kit

A new dealer phono-drive kit, called the "G-C P100 Phono Kit," is being produced by General Cement Mfg. Co. There are 51 exact replacement drives in the new kit, making it easy to service a majority of popular record changers and tape recorders. The G-C line includes a total of 78 different styles being available to meet every phono servicing problem. A complete reference chart, suitable for wall mounting, is packed with each kit. For data, check C16.

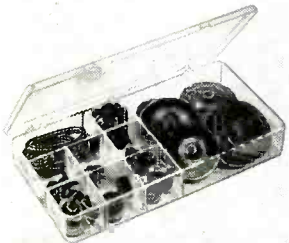

## Cole-Hersee Switches

Cole-Hersee Co. is marketing switches for use in automobiles equipped with power operated antennas and front and rear seat speakers. Push-pull momentary antenna switches No. 9137 and 9136 are used to raise and lower power-operated antennas from the driver's seat. Three position rotary switches Nos. 7543 and 7595 permit independent or simultaneous operation of front and rear seat speakers. Each of these switches is supplied with ivory plastic knobs firmly attached with a hardened set screw. For data, check C18.

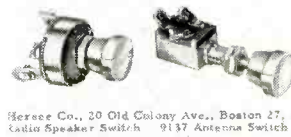

Hersee Co., 20 Old Colony Ave., Boston 27, 8  
Radio Speaker Switch 9137 Antenna Switch

## Merit Flybacks

Merit Coil & Transformer Corp. is now manufacturing two flyback transformers for exact replacement. The HVO-50 is an exact replacement for Trav-ler and may be used to replace part numbers TV-X-104 through and including TV-X-114 used in more than 75 Trav-ler models and chassis. The HVO-52 is an exact replacement part for Hallcrafters, Coronado, Silvertone and Tru-tone. It can be used to replace parts numbers 55C133, 55C143 and 55C144, used in more than 50 models and chassis. For data, check C14.

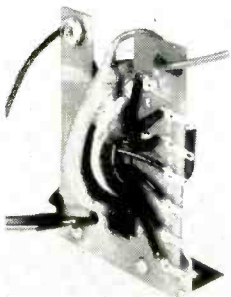

## Radiart Display

With some 45 models available, the Radiart Corp. announces modernization and expansion of its VIPOWER line of vibrator-powered converters. To merchandise this line most effectively, Radiart is making available to distributors, free with initial stock orders, an impressive "Consumer Department," 2-color, metal rack, occupying less than 2 1/2 feet of floor space, which strikingly displays a wide variety of converters. The line covers a range of AC-to-DC power outputs from 2 to 350 watts. For details, check C11.



## Merad Cement

New, fast-drying industrial coatings and adhesives of extreme bonding strength which will not shrink or embrittle are now available in "custom" formulations from Merad Laboratories, Inc. Merad coatings and adhesives are solvent-release synthetic resin formulations which will not shrink or embrittle under the most adverse conditions. They become stronger with age, and in most cases are stronger than the materials they bond. Chemically inert, the formulations will not cause rust or corrosion. Drying rate can be controlled from a few seconds to 24 hours. A smooth, clear, glossy film is guaranteed with no sagging or wrinkling at bonding points. For data, check C17.

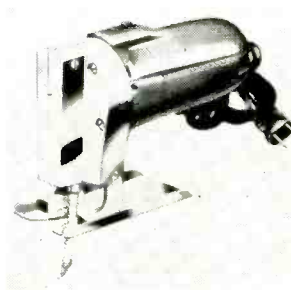

## WEN Saw

This new Model 505 Saw, introduced by WEN Products, has a simple method of counterbalancing the reciprocating parts that holds vibration to a minimum, and a fan which blows an airstream over the work to keep the guide line free of sawdust. The Saw is 6 3/4" long, 5" high (less blade) and has a shipping weight of 4 1/2 lbs., individually packed. It is powered by a 115 volt, a.c./d.c., 1.8 amp. motor. Fine, medium and coarse blades are supplied with each saw. Blades have a 5/8 inch stroke and the motor delivers 2650 strokes per minute under load. For further data, check C10.



Mfr: Emerson Chassis No. 120220-D,  
120239-D, F

Card No: EM120220-1

Section Affected: Pix

Symptom: Moving hum bar in pix in areas where receiver and transmitter sources of power are not in sync.

Reason for Change: Circuit improvement.

(Chassis incorporating this change have been coded as follows: 120220-D<sub>R</sub>, 120239<sub>R</sub>, 120239<sub>A</sub>).

What to Do:

Install: .047  $\mu$ f — 400 V condensers between tuner agc lug and ground.

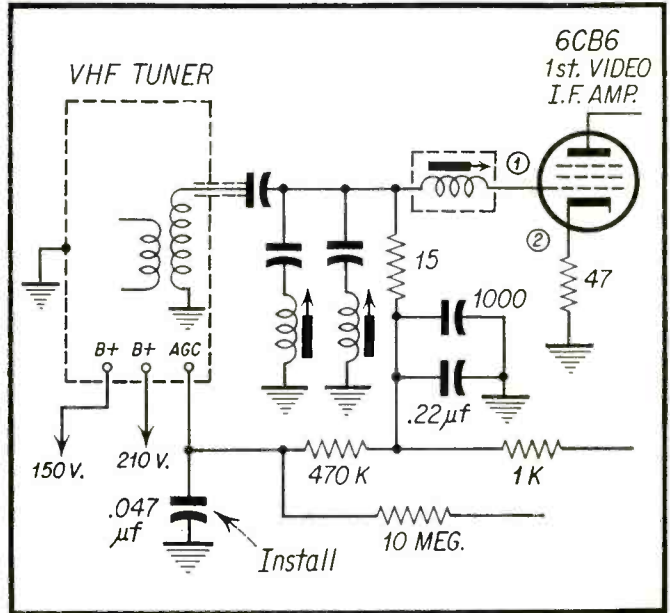

Mfr: Emerson Chassis No. 120220-D,  
120239-D, F

Card No: EM120220-2

Section Affected: Sound

Symptom: Audio response not up to par.

Reason for Change: Circuit improvement. (Chassis incorporating this change have been coded as follows: 120220-D<sub>C</sub>, 120239-D<sub>C</sub>).

What to Do:

Install: 6.8K  $\frac{1}{2}$ W resistor in top side of volume control.

Also, .002  $\mu$ f — 400 V condenser across volume control.

Change: C31 (.0047  $\mu$ f) to .001  $\mu$ f — 400 V and C33 (.47  $\mu$ f) to .01  $\mu$ f — 600 V.

Note: If audio buzz is encountered try different 12AX7 tubes. If audio buzz persists restore set to original condition except that C33 is left at .01  $\mu$ f — 600 V.

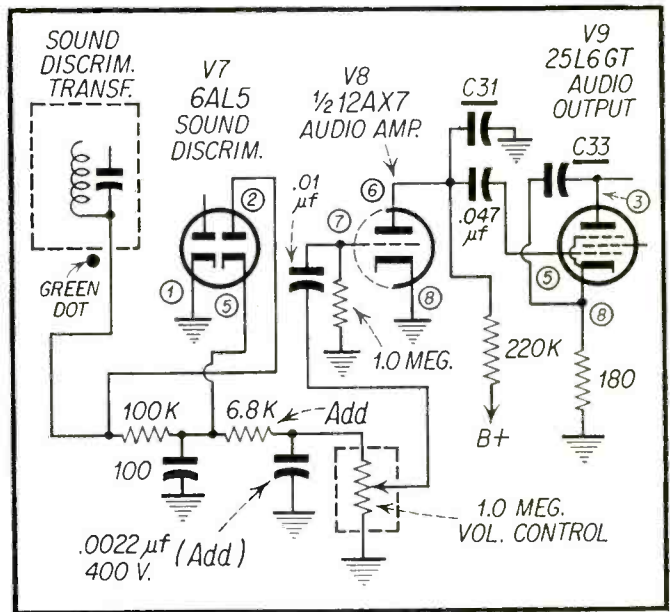

Mfr: Emerson Chassis No. 120239-F (17")

Card No: EM120220-3

Section Affected: Sound

Symptom: Audio buzz in strong signal areas.

Cause: Tuner overload.

(Chassis incorporating this change are coded as follows: 120239-F<sub>1</sub>, 120239-F<sub>2</sub>).

What to Do:

Change: R28 (10 meg) agc delay resistor to 15 meg.

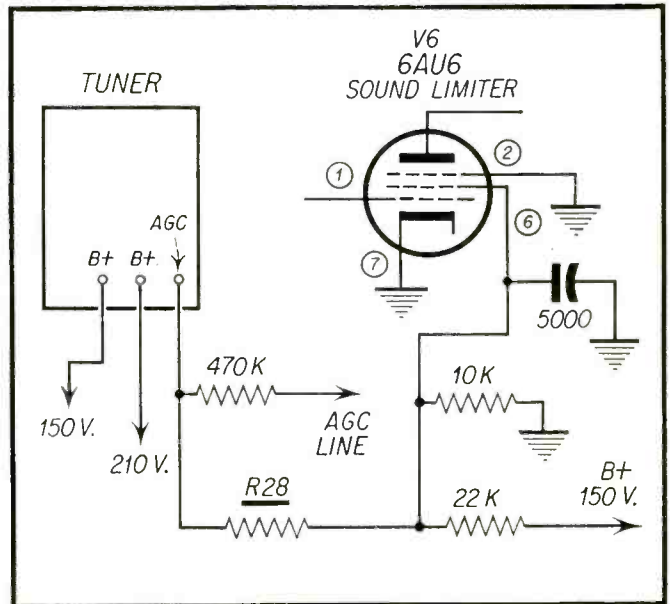

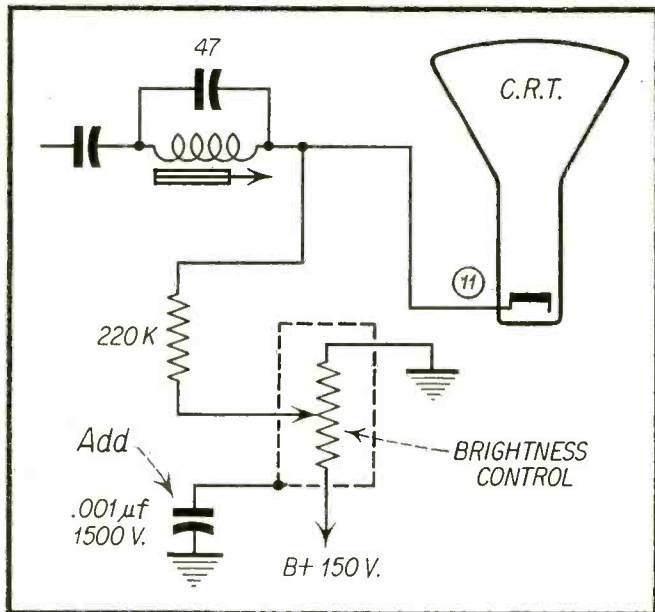

Mfr: Emerson Chassis No. 120220-D,  
120239-D

Card No: EM120220-4

Section Affected: Sound

Symptom: Buzz pickup

Reason for Change: Reduce buzz pickup.

(Chassis incorporating this change are coded as follows: 120220-O<sub>H</sub>, 120239-D<sub>H</sub>).

What to Do:

Add: 1000 μf — 1500 V ceramic condenser between brightness control case and chassis.

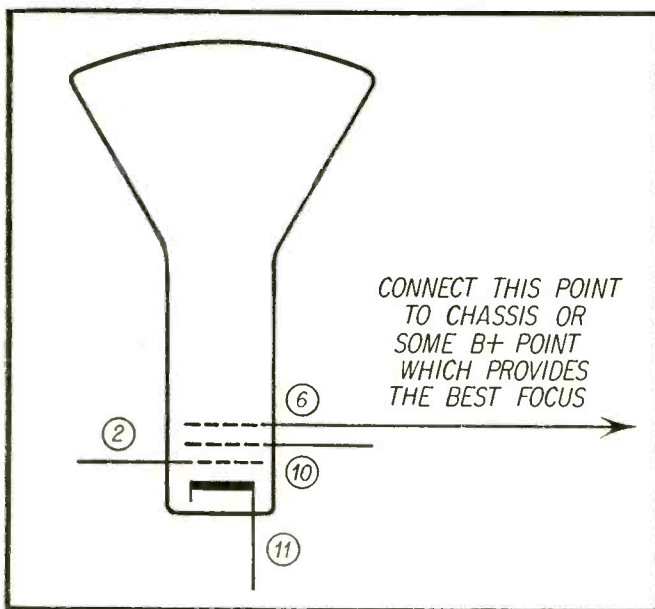

CONNECT THIS POINT TO CHASSIS OR SOME B+ POINT WHICH PROVIDES THE BEST FOCUS

Mfr: Emerson Chassis No. 120220-D,  
120239-D, -F, 120251-D,  
120254-D

Card No: EM120220-5

Section Affected: Raster

Symptom: Focus not up to par.

Reason for Change: Better overall focus.

(Chassis already incorporating this change are coded as follows: 120220-D<sub>I</sub>, 120239-D<sub>I</sub>, 120239-F<sub>E</sub>, 120251-D<sub>A</sub>, 120254-D<sub>A</sub>).

What to Do:

Reconnect: Red lead from kinescope socket (Pin 6) and connect to B+ point which provides best overall focus.

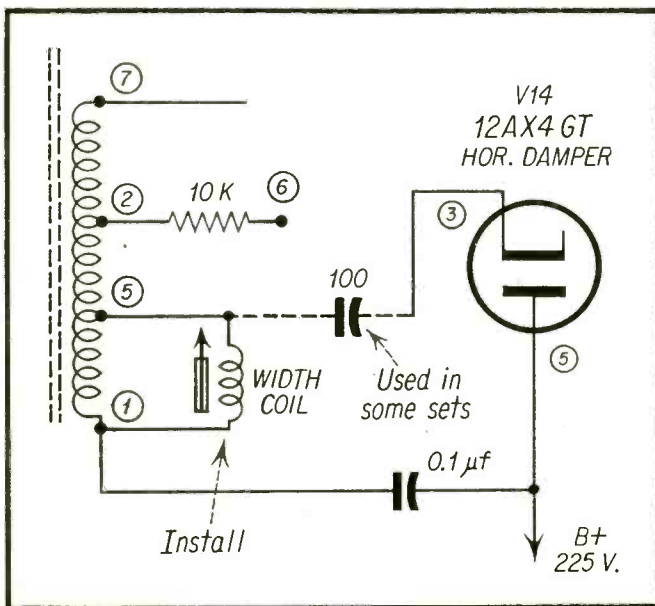

Mfr: Emerson Chassis No. 120220-D,  
120239-D, -F, 120251-D,  
120254-D

Card No: EM120220-6

Section Affected: Raster

Symptom: Too much width.

Cause: Line voltage too high.

(Chassis incorporating this change are coded as follows: 120239-D<sub>I</sub>, 120239-F<sub>E</sub>, 120251-D<sub>H1</sub>, 120254-D<sub>H1</sub>).

What to Do:

Install: Width coil (part #708068 or equivalent).



# RADIO-TELEVISION SERVICE DEALER

# INDEX FOR 1955

## Answerman

Admiral 21F1: No vertical deflection	Mar. 36
Admiral 19K1: Horiz. Instability	Sept. 33
CBS-Columbia 921-14: No sound	Aug. 40
Crosley 431-2: Condenser Failure	Nov. 27
Cross Modulation	July 38
Du Mont RA-312: Pix overload and poor sync	Jan. 39
Freed Eismann ch. 700-121: Horizontal Transformer incorrectly wired	Oct. 38
Frequency response oscilloscope	May 46
Ion trap adjustment and tube life	June 46
Motorola TV 25BQ6 Burnouts	Feb. 44
Motorola TS-525: Critical horizontal hold	Aug. 40
Multi-set antenna coupling	Apr. 33
No horizontal and vertical sync	Apr. 33
Overloaded picture	July 38
Picture Tubes: Arcing in neck	Mar. 36
Replacement windings for flybacks	Aug. 42
Snow reduction in fringe areas	June 46
Stromberg-Carlson Model 24: Cathode to filament short	Feb. 44
Stromberg-Carlson 21TQ: Ion trap focus adjustment	Sept. 33
Stromberg-Carlson X21: Frequent high voltage fuse failure	Oct. 38
Westinghouse ch. V2345: Horizontal streaking	Oct. 38
Westinghouse V2313: No picture, No sound	Nov. 27
Westinghouse V2318: Elimination of audio hiss	Sept. 33
Zenith 19R20: Noise	May 47
1B3 replacement	Apr. 34
5U4 failure	Oct. 45
6BQ7 replacement in standard coil tuner	May 46
6BK7-6BQ7 substitution	June 46
12-volt operation of a six-volt car radio	Dec. 46

## Association News

Associated Independent TV Servicemen, Buffalo, N.Y.	Apr. 51
Association of TV Service Companies, Cincinnati	Mar. 43, Nov. 42
Associated Radio-Television Service Dealers, Columbus, Ohio	May 27, July 39
Associated Radio and Television Servicemen, Chicago, Ill.	Feb. 49, May 26, Sept. 45, Nov. 42
California State Association	Dec. 16
California TV Convention	Aug. 53
Empire State Federation of Electronic Technicians Associations	Feb. 49, Aug. 7
Federation of Radio Servicemen's Association, Pa.	Feb. 50, May 26, July 40, Aug. 53, Oct. 47
Hazleton (Pa.) Service Group	Apr. 51
Long Beach Radio Technicians Association, (Calif.)	Sept. 46
Long Island Electronic Technicians Association	Jan. 6, May 20, July 39, Dec. 16
Middle Tennessee TV Technicians Association	Aug. 53
Milwaukee Association of Radio and TV Servicemen	June 24
National Electronic Technician's and Service Dealer's Association of N.Y.	Jan. 41
National Alliance of Television and Electronic Service Associations	Apr. 51, May 20, June 24, Aug. 52, Sept. 45, Oct. 27, Nov. 21, Dec. 16
New Hampshire Radio and TV Assn.	Mar. 42
Northeast Television Service Dealers Assn., Philadelphia	July 37
Philadelphia Radio Servicemen's Association	June 24, July 37, Oct. 48, Nov. 42, Dec. 16
Radio Technician's Association of Southern California	Mar. 16
Radio-TV Service Association of St. Paul, Minn.	Mar. 42
Radio-TV Technician's Guild of Long Island	Mar. 16
Radio-TV Technicians Association of Orange County, California	Sept. 46, Oct. 49
Radio and TV Association of Santa Clara Valley, Calif.	July 37
Radio TV Association of Kalamazoo, Mich.	June 44

Radio and TV Association of Springfield, Ohio	Feb. 49, Sept. 46, Oct. 48
Radio and TV Servicemen's Association of Pittsburgh, Pa.	Feb. 49, May 55, June 24, Aug. 52
Radio Television Guild of Long Island	Jan. 6, Feb. 50, May 20, Nov. 21
Radio and Television Electronic Technician's Association, N.Y.	Mar. 43, May 26
RTA of Santa Clara Valley, Calif.	Dec. 14
Southern Pennsylvania Radio and TV Technicians Association	Jan. 6, Mar. 16
Southwest Missouri TV Technicians	Dec. 15
Syracuse TV Technician's Assn.	Feb. 49, Apr. 51, June 24
Technician's Electronic Service Association, Connecticut	Aug. 52
Television Installation Servicemen's Association, Chicago	Feb. 50, Apr. 51, Aug. 53
Television Installation Service Association, Denver	Jan. 41
Television Service Dealers Association of Philadelphia	June 24
Television Service Association of Connecticut, Inc.	May 55
Television Service Association of Michigan	May 26
TELSA—Connecticut	Dec. 50
Texas Radio-TV Dealers and Servicemen	Aug. 53
Texas Electronics Association, Inc.	Sept. 45
TV Installation Service Assn., Illinois	Mar. 43
TV Association of Oklahoma	Dec. 16
Unity Meeting Held in Pittsburgh	Oct. 27
Utah Association of Radio and Television Servicemen	June 24

## Circuit Analysis

Admiral 21A3Z—Voltage Distribution	May 36
Du Mont narrow band sync amplifier	Sept. 40
Noise Control Circuit, Emerson Ch. 120174B	June 37
Emerson Noise Control Circuit (concluded) and the Motorola Volumatic circuit	July 17
Motorola TS-531, 609: Horizontal afc phase detector	Aug. 21
Philco Chassis TV-350, 354	Apr. 14

## Editorial

Another Milestone	Apr. 4
An Outrage	June 20
A Paradox	July 4
Color TV Here At Last	Nov. 4
Color TV Outlook	May 4
Crack-Down on Gyps	Jan. 4
Correcting the Fault	July 4
Don't Overlook Hi-Fi	Aug. 5
Free Enterprise	Sept. 8
Gyps Get Jail Terms	Apr. 4
John F. "Rider Speaks"	Oct. 6
July—What's Your Verdict?	Oct. 6
National Television Servicemen's Week	Feb. 4
Nation-Wide Servicemen's Association	Aug. 5
New Items to Service and Sell	Nov. 4
Our Field Needs to be United	July 4
Predictions and Results	Mar. 4
Printed Circuitry and Transistors	June 4
Service Field Magazines	May 4
Specialized Test Equipment	Jan. 4
Technical Courses by Manufacturers	May 4
The Readers Write	Nov. 4
The Verdict is in	Dec. 8
Transistorization	June 20
Tube Tester Innovation	May 4
TV Antenna Sales Potential	Feb. 4
Two-Way Radio Servicing	Apr. 4
1954 TV Sales	Feb. 4
\$15,000 Per Year Servicemen	Sept. 8
What's happening with Color TV	Aug. 5
Wholesale Servicing Opposed	Mar. 4
You Asked For Them	Oct. 6

## Feature Articles

AGC Problems, by Paul Goldberg	Apr. 35
--------------------------------	---------

A High Voltage Capacitance Probe, by Charles I. Benson	Apr. 20
A Miniature Volt-Ohmmeter, by Edward McArdle	Mar. 41
A New High in VTVM Compactness, by James P. Connor	June 41
A New Instrument for testing and Repairing Cathode Ray Tubes, by Engineering Dept., Raytronic Laboratories, Inc.	Jan. 14
A New Portable Multimeter, by George C. Dormeyer	Apr. 17
A New White-Dot Generator, by Robert G. Middleton	Sept. 26
A roundup of 1955 Portable Receivers, by Sol Heller	June 12
An "In Circuit" Condenser Checker, by George Reade	Nov. 15
An Unusual Horizontal Output Tester, by E. A. Bromsem	Jan. 21
Audio Output Stage Used as B Voltage Divider, by Paul Goldberg	Nov. 25
Auto Ignition Interference Suppression, by Steve Travis	Jan. 19
Auto Radio and Electronic Accessories, by Steve Travis	Oct. 9
Brightness Problems, by Paul Goldberg	Feb. 23
Brilliance Defects in TV Receivers, by Matthew Mandl	Feb. 9
Broad Band Antenna Systems, by Douglas H. Carpenter	May 29
Butchered Receivers, by Paul Goldberg	July 20
Chrominance Systems in Color TV Receivers, by Bob Dargan and Sam Marshall	Jan. 9
Part 2	Feb. 14
Part 3	Mar. 15
Part 4	Apr. 30
Part 5	May 32
Part 6	June 14
Color Convergence with a White-Dot Linearity Generator, by Winston H. Starks	Feb. 27
Color Convergence with a White-Dot Linearity Generator, by Joseph Hill	Apr. 9
Color Display Patterns, by Bob Dargan and Sam Marshall	Nov. 28
Color Signal Output Systems, by Bob Dargan and Sam Marshall	June 6
Part 1	July 11
Part 2	Aug. 11
Part 3	Aug. 11
Color Sync Analysis, by Bob Dargan and Sam Marshall	Dec. 25
Compound Diffraction Projection loudspeakers, by Charles Eastman	June 22
Constant Voltage Line Distribution System, by L. A. Stineman	Apr. 22
Convergence Patterns, by Bob Dargan and Sam Marshall	Sept. 15
Part 1	Oct. 29
Part 2	June 16
Electrostatic Speakers in New Hi-Fi Units, by Steve Travis	June 16
Filter Condenser Problems, by Paul Goldberg	Oct. 20
Geiger Counters, part 1, by Oscar Fisch	Sept. 20
Horizontal Frequency Problems, by Paul Goldberg	Sept. 25
Intensity Markers for Sweep Alignment, by Oscar Fisch	Dec. 21
Microphonic and Sound Bar Problems, by Paul Goldberg	May 35
New Chassis Design Features	Nov. 33
P. A. in Supermarkets, by Gene Hessel	May 23
Peak to Peak Comparison Meter, by R. H. Bowden	Feb. 37
Peak to Peak VTVM, by Harry C. Ashley and Philip Portnoy	May 44
Peculiar Symptoms Due to Defective Tubes, by Paul Goldberg	Dec. 29
RCA National Servicemen's Week	Feb. 43
Roundup of Indoor P.A. Components, by Sol Heller	Mar. 11
Schools for Service	Dec. 43
Selling and Servicing TV Antenna Rotators, by Clifford P. Shearer	Feb. 46
Selling Hi-Fi, by Herbert Suesholtz	Nov. 35
Scintillation Counters, part 2, by Oscar Fisch	Oct. 22
Series Filaments, by Steve Travis	May 7

Servicing With the Square Wave Generator, by Oscar Fisch	
Part 1	Mar. 34
Part 2	Apr. 25
Part 3	May 11
Signal Seeking in Auto Radios, by Steve Travis	
Part 1	July 7
Part 2	Aug. 18
Testing and Rejuvenating Picture Tubes, by Milton S. Kiver	
	Jan. 24
Testing Flyback Transformers, by Steve Travis	
	Nov. 9
The Future of the Antenna Industry, by J. L. Wade	
	Sept. 28
The New GE Color Tube	
	Dec. 32
The Capacitester, by Sol Heller	
	Oct. 19
Troubleshooting Oscilloscope, by Harold White	
	Oct. 12
TV Instrument Clinic, by Robert G. Middleton	
Part 7	Jan. 24
Part 8	Feb. 24
Part 9	Mar. 23
TV Receiver Troubles, by Paul Goldberg	
	Aug. 37
TV Tuner Repairs, by Donald Quaranta	
	Dec. 11
Unusual Tube Trouble Case Histories, by Arthur Coleman	
	Apr. 45
Vertical Problems, by Paul Goldberg	
	Mar. 23
Video Problems, by Paul Goldberg	
	June 21
Voltage Regulating Transformers, by Larry Stincman	
	Dec. 39
White Dot Generators	
	Aug. 9
Width Problems, by Paul Goldberg	
	Jan. 22

### New Products

New Products	
Jan. 40, Feb. 48, Mar. 46,	
Apr. 46-47, May 48, June 42, July 36, Aug.	
43-44, Sept. 24-31-34-39, Oct. 26-37-40, Nov.	
24-31-32-34, Dec. 28-34-40-42-44	

### Radio-TV Service Dealer Complete Manufacturer's Schematics

Motorola Y21 & Y24 Series	Dec. 57
RCA models 17PT, 21S, 21T & 21D	Nov. 57

### Rider Speaks

John F. Rider Speaks	Nov. 19, Dec. 41
----------------------	------------------

### Rider TV Field Manual Service Data Sheets

Capchert CX-38	Mar. 25
Crosley chassis 466 & 467	Oct. 27
Du Mont chassis RA 321 and RA 322	Jan. 25
GE Models 21C40-41, etc.	July 21-28
RCA Model 21-S-500R "Special 21", Chassis KCS93B	Aug. 25
Sears Meteor Chassis 637,12420	Sept. 57
Sarpton Chassis 29U244, 29D22	Feb. 65
Stromberg-Carlson 625 Series	May 65
Westinghouse Model H-838K21, A, B,	

### Trade Flashes

Trade Flashes	Jan. 44, Feb. 57, Mar. 6,
	Apr. 48, May 9, July 13, Aug. 46, Sept. 12,
	Oct. 24, Nov. 22, Dec. 48

### TV Service Information Sheets

Emerson "VHF" and "All Channel" VHF and UHF receivers	
	Jan. 37
Fada Mod. S4C20	
	Apr. 37
GE Mod. 17C127, 17T15-17, 21C114-115, etc.	
	June 39
Muntz Model 317T2, Ch. 37A2 Mod. 31T1, Ch. 17B2	
	July 33
Packard Bell 2742, -43, -44, etc.	
	Feb. 39
Sentinel Model 1U581, -582, -584-585	
	May 41
Silverstone Mod. 173-16	
	Apr. 39
Stewart-Warner, Models 21C9340, etc., and 21T-9340B, etc.	
	Feb. 41
Westinghouse Ch. V-2249-1	
	Aug. 23
Zenith Mod. K2872R, K2873E, Ch. 28K20	
	Mar. 39

### Video Speed Servicing Systems

Admiral 19B1	July 29
Admiral 17XP3	Nov. 37
Andrea Model T-VL16	Feb. 33
Arvin Ch. TE-276	Feb. 35
Capchert CX-38S	Dec. 35
Crosley 431-3, 432-3	Dec. 38

Du Mont RA 312-313	Nov. 39
Du Mont RA-162	Oct. 33
Emerson Model 680D, ch. 120140-B	May 37
Fada Model S1055	Mar. 37
GE 21C119	July 31
Majestic 21C31	Sept. 35
Montgomery Ward Models 25WG3060A, 25WG2070A	Apr. 43
Motorola Models 24K1, 1B, 24K2, 2B, etc.	Apr. 41
Motorola Chassis TS-525	May 39
Olympic 17K41	Sept. 37
Philco chassis TV 300	June 35
Philco Chassis TV 350	June 33
RCA KCS83C	Aug. 33
Stromberg-Carlson 521 series	Jan. 35
Westinghouse CH-V-2175	Oct. 35
Westinghouse ch. V-2208-1	Aug. 35

### Workbench

Admiral 19F1A: Foldover at bottom	Mar. 24
Admiral 19E1: Microphonic	May 35
Admiral 22E2: Blooming	July 20
Admiral 18XP4BZ	Sept. 48
Admiral 21J1	Oct. 20
Admiral 2021	Nov. 54
Admiral RA-164	Dec. 30
Du Mont RA164	Nov. 25
Du Mont RA 109: Smear Pix	June 21
Du Mont RA109: Sound Bars in Pix	May 35
Du Mont RA-109: Smear Pix	June 21
Du Mont RA 112	Oct. 21
Du Mont RA-306: Video overload	Apr. 36
Emerson 734B, Ch. 120169-B: Vertical frequency drift	Mar. 52
Emerson 120163D: Video Overload	Apr. 52
GE 830-T: No Brightness	Feb. 23
GE 16T1: Brightness	Aug. 37
Kent "7" Series	Sept. 25
Motorola TS101: "S" bend in pix	July 46
Motorola TS101: Video-Sound	Aug. 37
RCA KCS68C: Insufficient width	Jan. 22
Shaw X224: Video overload	Apr. 35
Sylvania 1-508-1: Insufficient width and high voltage	Jan. 22
Techmaster 1631: AGC	Aug. 37
Westinghouse H-606K12	Nov. 25
Westinghouse 1250-101: Low video gain	June 21
Westinghouse H649T17: Hum	July 20
Zenith 21J1	Oct. 20
Zenith Ch. 27F20: No Brightness	Feb. 23
630 Type chassis	Dec. 29

# SPECIAL OFFER TO OUR READERS!

By special arrangement with John F. Rider Publisher, Inc., RADIO-TV SERVICE DEALER now brings you a COMPLETE diagram service to help you do a faster, easier servicing job!

**ALL COMPLETE! ALL FACTORY PREPARED! ALL FACTORY AUTHORIZED!**

- ✓ Just \$1.25 for COMPLETE SERVICING INFORMATION on any TV receiver . . . any year, any make, any model . . . from 1946 on!
- ✓ Just 75¢ for COMPLETE SERVICING INFORMATION on any radio . . . any year, any make, any model . . . from 1941 on!

TAKE ADVANTAGE OF THIS SPECIAL OFFER . . . MAIL THE COUPON TODAY!

Radio-TV Service Dealer, 67 W. 44 Street, New York 36, N. Y.

Please RUSH me the following diagrams:

RADIO DIAGRAMS @ 75¢ EACH		
CHASSIS #	MAKE	MODEL #

TV DIAGRAMS @ \$1.25 EACH		
CHASSIS #	MAKE	MODEL #

MAKE ALL CHECKS & MONEY ORDERS PAYABLE TO Radio-TV Service Dealer  
(For all New York City orders, please submit additional 3% sales tax.)

Name .....

Address .....

City ..... State .....



## TRADE FLASHES

[from page 7]

Radio and Television Division of Sylvania Electric Products Inc., starting in April, 1956. Arthur L. Chapman, Vice President-Operations, said, "We have waited until we were confident a color set could be manufactured meeting our own requirements for color quality, reception and other factors. We feel it now can be done." Mr. Chapman said the Sylvania color sets would have 21-inch picture screens with 250 square inches of viewing surface. The picture tube to be used, he said, is "tested in our own production over the past year," during which Sylvania has manufactured color tubes for several other set makers.

*H. G. Cisin's TV & Radio Tube Substitution Guide provides a serviceman with valuable data for the replacement of tubes in TV sets, radios and other electronic equipment in instances where the identical replacement type is unobtainable. All tubes suggested for substitution have characteristics similar to the tubes that are to replace them and will fit in the same socket and do not require any changes in wiring whatsoever.*

America's electronics industry will attain sales and revenues of approximately \$10,800,000,000 in 1956, nearly a billion dollars greater than the 1955 volume, Don G. Mitchell, Chairman and President of Sylvania Electric Products Inc., predicts. Mr. Mitchell also estimated that the industry's volume would exceed \$15,600,000,000 by 1960, and \$22,000,000,000 by 1965. In discussing the potential of television, Mr. Mitchell pointed out that about 7,600,000 sets will be sold to the public during 1955, representing television's biggest year to date. The dollar volume of factory sales of television receivers will total \$1,055,000,000. He estimated that TV set sales to the public in 1956 would be approximately 7,500,000, about 200,000 being color sets. This would total a factory-door value around the billion dollar mark. In 1960, combined sales of monochrome and color sets are expected to total about 9,600,000, a new record, with dollar value of about \$1,521,000,000. At the end of the ten-year span, in 1965, it is likely that 11,600,000 sets will be sold, at a factory price level of nearly \$2,000,000,000. In contrast to the relatively small percentage of color sets in the 1956 total, Mr. Mitchell pointed out, about 31 per cent of all sets sold to the public in 1960 will be

# Simpson...the most Complete Line of VOM's

Select the one that fits your needs!

MODEL  
**260**  
world's most popular!

Over half a million Model 260's have been sold to date! 20,000 Ohms per volt. You'll find it wherever quick, accurate, electrical checks are needed. It's so handy, so dependable, so sensibly priced! Ask your jobber. Price, including Adjust-A-Vue Handle, only ... **\$38.95**

Carrying Cases from **\$6.75**

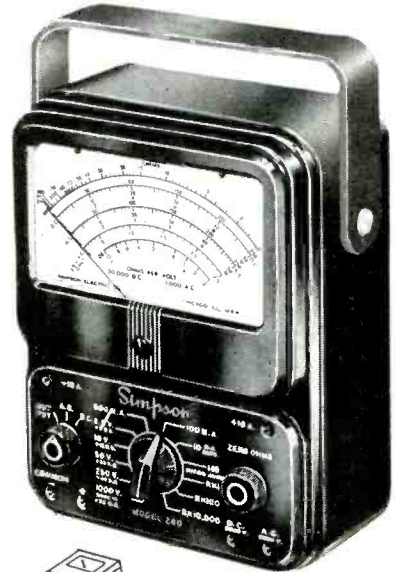

MODEL **262**

*Deluxe!*

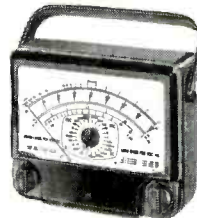

the new VOM with a 7" meter

20,000 Ohms per volt DC and 5,000 Ohms per volt AC sensitivity ... 33 ranges ... compact 7" case with Adjust-A-Vue Handle ... **\$59.50**

Carrying Case ... **\$ 9.95**

**NEW!**



**MIDGETESTER** Model 355—New shirt-pocket size Volt-Ohmmeter **\$29.95**  
**MODEL 240**—Small VOM; 14 ranges; up to 3000 volts AC or DC **\$26.35**  
**MODEL 230**—Small VOM; 12 ranges; up to 1000 volts AC or DC **\$24.95**  
**ROJO RANGER** Model 221—25 Separate meters at turn of a switch **\$75.00**  
**LABORATORY STANDARD**—For instrument calibration. Price on application.

MODEL **269**

100,000 Ohms per volt!



Most sensitive VOM

available! A Volt-Ohm-Microammeter with a big 7" meter in a compact 7" case ... 33 ranges ... Adjust-A-Vue Handle ... **\$88.00**  
price complete ...

Carrying Case ... **\$ 9.95**

# Simpson

## ELECTRIC COMPANY

World's Largest Manufacturer of Electronic Test Equipment

5200 W. Kinzie St., Chicago 44, Ill. • Estebrook 9-1121  
In Canada: Bach-Simpson, Ltd., London, Ontario

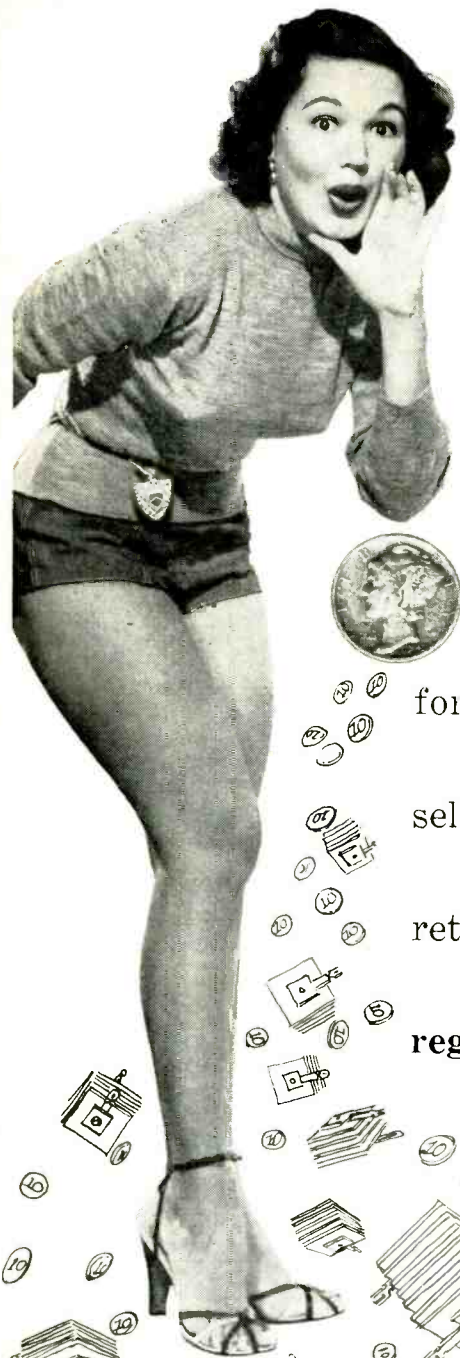

HAVE YOU  
HEARD that  
our distributors  
will allow you  
10c credit  
for each replaced  
selenium rectifier  
returned —  
regardless of make?

The selenium situation is critical, and reclamation is necessary to meet civilian, as well as military requirements. You can help by returning every replaced selenium rectifier to your distributor for credit.

**Sarkes Tarzian, Inc., RECTIFIER DIVISION** 415 N. COLLEGE AVE.  
BLOOMINGTON, INDIANA

In Canada: 700 Weston Rd., Toronto 9, Tel. Murray 7535

Export: Ad Auriema, Inc., New York City

color sets, and 72 per cent of total set sales in 1965.

"Color is on the way, after a slow start," Mr. Mitchell said. "But it will be some time before color sets will be marketed in large quantities, and it will be about six years before color television unit sales catch up with black-and-white."

Radio set production passed the 1.5 million mark in October, the highest output level attained in a four-week reporting period since February of 1948, the Radio-Electronics-Television Manufacturers Association reported recently. From January through October, 11,527,568 sets were turned out compared with 8,040,230 in the same period of 1954 when total production was just over 10.4 million. Unit output of television receivers declined to 759,735 in four-week October, RETMA reported, compared with 939,515 in September, a five-week period. During October a year earlier, 921,476 TV sets had been manufactured. Through October, 6,520,241 television receivers were manufactured compared with 5,654,791 turned out in the same period of 1954. Of the October TV output, 109,574 sets were manufactured with UHF tuning facilities, bringing the 10-month total to 977,537. FM radio production increased to 38,920 in October while an additional 5,749 TV sets with FM tuners were manufactured.

The Radio-Electronics-Television Manufacturers Association filed an extensive petition with the Federal Trade Commission requesting amendment of two Trade Practice Rules for the Radio and Television Industry which are scheduled to become effective Dec. 28. The two rules which RETMA recommended be amended relate to the method of designating television screen sizes and a requirement that television picture tubes using reprocessed glass in their manufacture be designated as "used." In connection with Rule 9, Deception as to Size of Picture, the RETMA petition points out that as promulgated by the FTC the rule offers "perhaps 20 different methods of measurement" as opposed to one standard system of screen size designation now used by the industry. The current "industry practice is neither deceptive nor unfair, and the change suggested . . . would be against the public interest," RETMA charged, "since the resulting confusion would be enormous." Comments on Rule 12 were confined to cathode ray tubes and the effect which the rule would have on the universal industry practice of re-using the outside container or envelope. Under the FTC proposal, a cathode ray tube in which a



used envelope is employed, but which is subjected to the same manufacturing process and tests as a tube using new glass, would have to be marked "used." RETMA contends there is no difference in the quality of picture tubes with re-used containers from those with unused containers if both have all new functional parts and if both have been subjected to the same manufacturing processes and standards.

An electronic tube warehouse and commercial service office has been established by the General Electric Tube Department at Seattle, Wash., to keep pace with the expansion of the electronic tube market in the northwest, according to W. C. Walsh, western regional manager of distributor sales. The tube warehouse is located at 220 Dawson Street, Seattle.

The first complete line of 21-inch color television receivers soon will be available to the public, it was announced by C. P. Baxter, Vice-President and General Manager, RCA Victor Television Division, Radio Corporation of America. The sets, all featuring RCA's simplified 26-tube circuits and the RCA 21-inch tricolor picture tube, will carry nationally-advertised list prices ranging from \$695 to \$995.

"Now for the first time, we are prepared to market a line of 21-inch color receivers. The receivers are of proven RCA Victor technical quality and ease-of-operation and will be produced in sufficient quantity, and supported by promotional activity of sufficient magnitude, to convince everyone, beyond any shadow of doubt, that color television will be big business for the industry in 1956," said Mr. Baxter.

## ANSWERMAN

[from page 19]

Now, if the positive *dc* voltage applied to the cathode and grid of the *age* amplifier tube is reduced for some reason the tube conducts more electrons, resulting in a greater negative voltage being developed in the *age* system. Also, if this *dc* voltage is reduced it results in a lower voltage supplied to the plate of the video amplifier. The video amplifier tube under these circumstances provides less signal at its output to be applied to the grid of the *age* amplifier bringing about the development of an even greater amount of negative *age* voltage. The total result can be a biasing of the *rf* and *if* stages to such an extent that the signal is cut off in these stages. This would be evident by a measurement of the negative voltage at the plate of the *age*

# HICKOK

## 650C

### COMPOSITE VIDEO GENERATOR

...PAYS FOR ITSELF QUICKLY

#### Through time saved in TV Trouble-Shooting



GENERATES ACTUAL TV  
COMPOSITE WAVEFORM

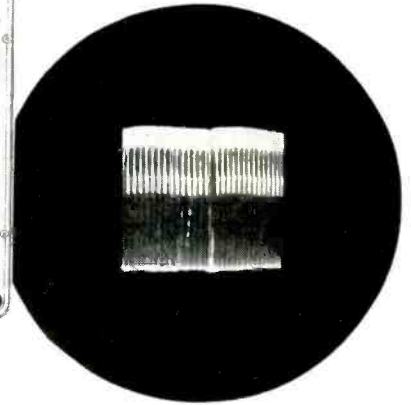

(plus 11 other patterns  
and waveforms)

The 650C is no ordinary bar-dot generator . . . it is the most complete composite video test instrument ever built . . . it is the perfect answer to your need for a quick and accurate method for isolating and identifying trouble in any stage of a TV receiver.

Enthusiastically accepted everywhere, the 650C has proven repeatedly that it pays for itself quickly through time saved in trouble-shooting. No single instrument has ever offered so many useful features to provide exceptionally fast and accurate methods for locating TV troubles.

## Easy to Use:

Horizontal and Vertical Framing Frequencies . . . this feature, for the first time, enables you to intelligently attack deflection circuit troubles such as horizontal streaking and horizontal foldover.

RF Output . . . covers all low and high channels and is calibrated directly in microvolts for sensitivity measurements to permit receiver adjustment for fringe or overload operation.

Actual TV Transmitter . . . a composite TV signal or program can be placed on any channel of a TV receiver.

Signal Tracing . . . the 650C is especially useful for signal tracing stage by stage from antenna to picture tube or for use in substitution techniques to by-pass any stage in quickly isolating troubles.

The 650C generates an actual Composite Video waveshape, 60 cycle Vertical Sync Pulse, 900 Cycle Pulse, 60 Cycle Vertical Sawtooth . . . plus, individual patterns at any signal strength within 0-10,000 microvolts. (Vertical or Horizontal Lines, Cross-Hatch, White or Black Dots or Framing Frequencies only.)

Other Uses . . .

- Trouble-shoot and adjust AGC circuits, video amplifiers and audio circuits
- Proper deflection yoke or ion trap adjustment
- Trouble-shoot sync circuits, vertical or horizontal deflection circuits
- Check frequency response of a receiver
- Set linearity and size to proper aspect ratio
- Set vertical and horizontal hold controls in absence of a station on the air
- Drive a TV camera or monoscope and re-broadcast on any one of the VHF channels
- Detect Hum in the Video Amplifier
- Identify poor isolation between horizontal and vertical deflection circuits including the high voltage section
- Converge Color TV receivers
- Analyze integrating and differentiating circuits
- No external sync is required.

Years of top HICKOK engineering and field testing were spent in perfecting and proving this remarkable piece of equipment.

Call your nearest Parts Jobber for a demonstration . . . or write direct for new 68 page book covering all applications of the remarkable 650C.

**THE HICKOK ELECTRICAL INSTRUMENT COMPANY**  
10533 Dupont Avenue • Cleveland 8, Ohio

**FOR MORE TUBE SALES, GREATER PROFITS...**

**"SELF SERVICE"**  
TELEVISION-RADIO TUBE TESTER

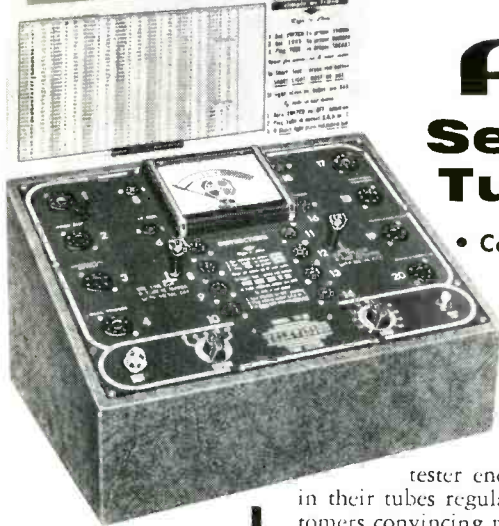

*NEW*  
**A·S·D**  
**Self-Service**  
**Tube Tester**

- Complete Customer Satisfaction
- Customer Does All the Work
  - Only 3 Simple Steps
  - Tests Over 400 TV and Radio Tubes • Increases Profitable Tube Sales

The new "ASD" TV-20 CS tube tester encourages your customers to bring in their tubes regularly for testing. It gives your customers convincing proof when tubes are bad!

Put the ASD tester on a counter or stand for customer use. It will increase profitable tube sales and bring prospects to your service store. Thousands are already in use. **DON'T LET THIS EXTRA-PROFIT BUSINESS SLIP BY...**

Model TV-20 CS  
**\$99.50**

*Write for information, or see your distributor.*

**AMERICAN SCIENTIFIC DEVELOPMENT COMPANY**  
Ft. Atkinson, Wisconsin

**NOW...check flybacks**  
**WITHOUT A REFERENCE!**

with the amazing, **NEW**

**TELETEST**

**FLYBACK**  
**TESTER**

**1-YEAR FACTORY**  
**SERVICE GUARANTEE**

**\$44.95**



Model FT-100

*Slightly higher west of the Rockies*

Engineered for the cost-conscious serviceman, here is the first and only flyback tester that reveals even one-turn shorts without a reference transformer for comparison!! This reliable test unit indicates true flyback condition under full operating voltage—100% of the time!

No costly flyback inventory!...No speculative parts replacement!...No calibration adjustment! Unsurpassed in sensitivity and simplicity, the TELETEST Flyback Tester is preferred by discriminating service technicians for accurate and economical checking of all types of flybacks, yoke windings, width and linearity coils.

Save time, effort and money with the new TELETEST Flyback Tester!

**TELETEST**

See your local Jobber or write TODAY for complete information to:  
**TELETEST INSTRUMENT CORPORATION**  
Dept. SD-1, 31-01 Linden Pl., Flushing 54, N. Y.

amplifier which is normally -20 volts. As can be noted the entire trouble hinges around the lower voltage being supplied to the cathode of the *agc* amplifier tube. Most probably this is caused by an increase in the value of R501, the 4300 ohm resistor which is a large wattage voltage dropping resistor in the B plus circuit.

The reason that sound is heard when a horizontal tube is taken out of the socket is because this also removes the positive pulse that is normally coupled to the plate of the *agc* amplifier for the development of the negative *agc* voltage. Without the pulse no negative voltage can be generated and thus the *if* circuits are opened up and signals pass.

Although this case involves a different receiver and circuit, the condition is somewhat similar to one considered a few months ago. It is presented because of the frequency of occurrence of this type of failure and the consistent confusion that is experienced in servicing this type of difficulty.

*Dear Sir:*

Do you know any easy method of troubleshooting the printed panel chassis? It is very difficult to circuit trace these chassis since generally the printed wire is on one side and the components are on the other. I find that by the time I go from one side to the other of the printed panel working my head back and forth like the pendulum on a metronome I have a stiff neck.

Are there any points about servicing of these panels that will speed up my repair work?

S. T.  
St. Louis, Mo.

One means of simplifying and speeding up the servicing of these printed wire panels is to place a 50 or 60 watt bulb in back of the panel. Generally, the panel is thin enough so that the components are silhouetted on the etched wire side.

There have been some suggestions made with regard to this to the manufacturers such as printing the symbols and connections of the components in black ink on the printed wire side but nothing has come of it yet.

Another point that should be realized is that not all pigtailed must be removed from the panels. In most cases it will be easier to leave the component lead in the panel with sufficient length so that the pigtail of the new component can be mechanically connected and then soldered to the original pigtail. This avoids the necessity of heating the panel and possibly causing damage. It would seem to be advisable to follow this procedure whenever possible.

Many technicians have questioned



TV set manufacturers as to whether these panels are available as replacement items. In almost all cases the reply has been in the affirmative but there has as yet not been any great need for them. Very seldom does the whole panel require replacement. If, as an example several etched leads should become damaged it is a simple job to connect the points together with ordinary hookup wire.

Dear Sir:

I have a condition in a Motorola TS-531 chassis where the sound is affected with a sync buzz and a slight amount of background noise. I know it is sync buzz because it is variable with the fine tuning control. I have made all the usual checks, such as tubes, voltages, adjustments and nothing has been of any help.

Can you suggest anything additional I can try?

K. P.  
Madison, Wisc.

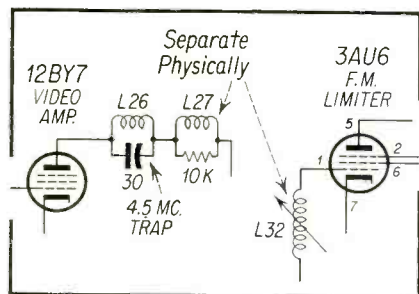

Fig. 3—Partial schematic of Motorola TS-531 circuitry.

Very frequently a condition of the type you have described can be minimized by component lead dress. In general, leads with strong video signals dressed near to grid leak resistors in the audio amplifier system can induce enough voltage to bring about this type of interference.

It is also possible that the video peaking coil, L27, is in close proximity to the sound if system such as the first if sound coil, L32. See Fig. 3.

Mr. Answerman:

How do I check the new tubes such as the 3CB6, etc., since they are not listed for my tube checker? Do these tubes correspond to the six volt type except for the filament voltage?

T. C.  
Los Angeles, Cal.

This is correct in that no case comes to mind where it doesn't apply. Where there exists a prototype of the 6 volt variety that is now designated as having a 3 volt filament the other tube characteristics are identical. These tubes are the new 600 ma. type with the con-

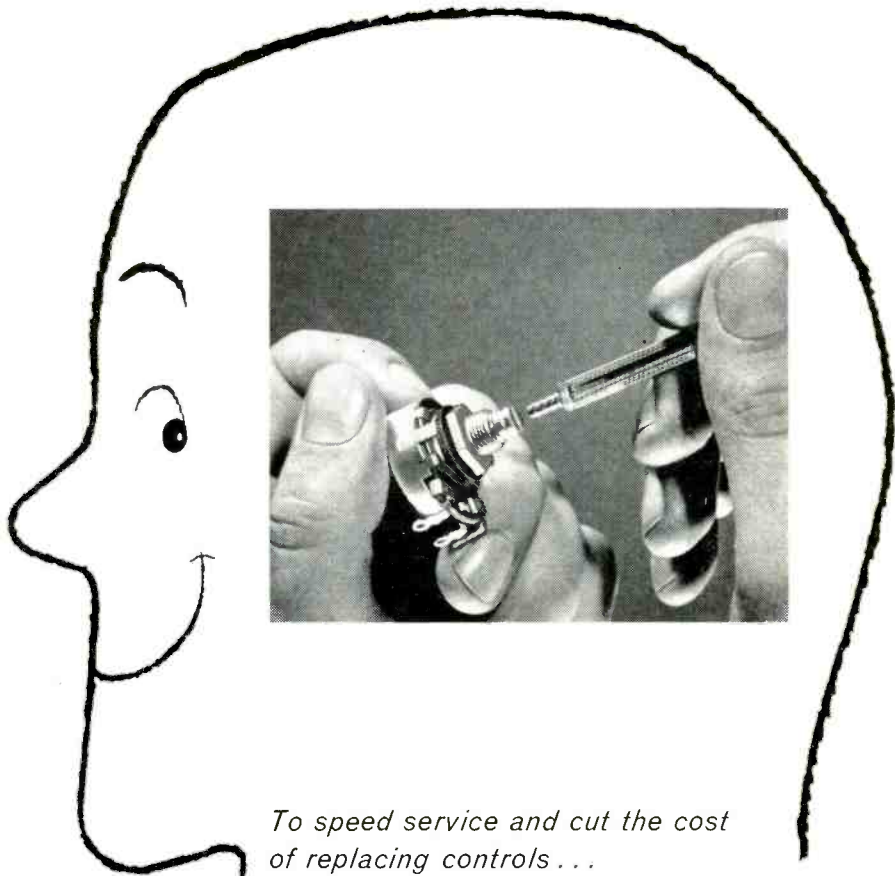

To speed service and cut the cost of replacing controls...

## It pays to think of Centralab Adashaft® Radiohms®



### ADASHAFT KIT NO. AB-100

An assortment of 39 most popular controls, switches, shafts, shaft extensions, and couplers. In hinged-lid plastic box. \$15.03 suggested net price.

Patented Adashaft design gives you *any resistance*

— including dual-tapped types ...

*with any shaft*

12 basic shaft types from 3/8" to 10" long, including auto types, insulating nylon, many others

...and you can convert to *switch types with Centralab "Fastatch" type KB line switches.*

Order Adashaft controls from your Centralab distributor. Both control *and* shaft cost no more than an ordinary control alone.

Send coupon for bulletin 42-199.

# Centralab

A DIVISION OF GLOBE-UNION INC.  
944A E. Keefe Avenue, Milwaukee 1, Wisconsin  
Send me Centralab bulletin 42-199.

B-561

Name.....  
Company.....  
Address.....  
City..... ( ) State.....

trolled heaters and they are generally employed in the series string receivers.

In the case you point out involving the 3CB6 tube its other characteristics are exactly the same as the 6CB6 tube except for their filament voltages which can be adjusted for on tube checkers. It is most important that this filament voltage setting on the tube checker be made before the tube is inserted. Otherwise, the filament knob may be in its filament setting for 6 volt tubes and damage can be caused to the filament of the 3 volt tube under test. Aside from this consideration the characteristics of the 6 volt equivalent tube is used in testing.

## FLASH-MATIC [from page 22]

with the contacts of the plate circuit relay. The cam operated switch contacts may be seen in Fig. 4 within the dashed rectangle representing the motor unit. The beam of light may now be removed from the photocell, and even though the contacts of SW-3 will open, the motor continues to turn since the circuit is held closed by the parallel contacts of the cam operated or "homing" switch.

The motor continues to turn until the cam makes one complete revolution. At this time, the cam once more actuates the switch trip latch, opens the homing switch, and the motor stops

rotating. The gear arrangement is such that when the index cam makes one revolution, the turret tuner is turned from one channel to the next.

Clockwise rotation is produced in a similar manner. The second triode of the 6BX7GT is the control tube. As mentioned previously, one side of the line is permanently connected to terminal #1 of the motor unit. When SW-4 (see Zenith schematic in insert) is actuated, it connects the other side of the line to terminal #4 of the motor unit, and the motor begins to turn the tuner in a clockwise direction. The clockwise homing switch then takes over. By the cam action previously described, the homing switch opens and stops the rotation when the tuner has moved to the next channel.

*Sure-  
Cure  
for  
Replacement  
Headaches:*



Replace with the **BEST**

# OXFORD SPEAKERS

"No more worrying after you've completed your replacement jobs" . . . that's the saying of more and more servicemen every day because they've switched to OXFORD REPLACEMENT SPEAKERS.

We GUARANTEE you products that are built to be replacement speakers. We stand behind each and every speaker with a 100% guarantee against any mechanical or electrical defects for one full year.

OXFORD Replacement Speakers undergo a rigid inspection to make certain that they are as good or better than the original speaker. That's why more servicemen are switching to OXFORD . . . the replacement speakers for a better job.

## OXFORD ELECTRIC CORPORATION

3911 SOUTH MICHIGAN AVENUE  
CHICAGO 15, ILLINOIS

EXPORT — ROBURN AGENCIES, NEW YORK CITY  
IN CANADA — ATLAS RADIO CORP. LTD., TORONTO

*Illustrated literature is available without obligation.*

. . . at better jobbers!

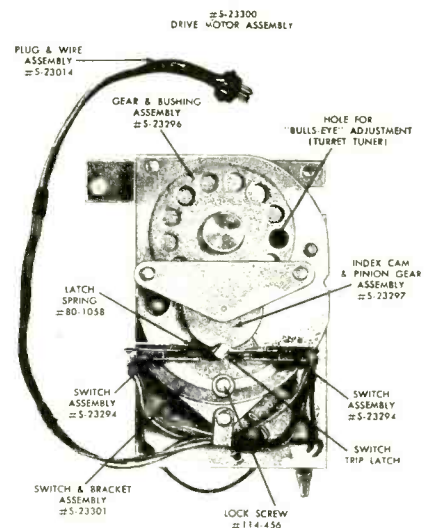

Fig. 5—Drive Motor assembly

The Switch SW-5 shown in Fig. 4 allows the motor to be operated from the panel without the use of a light beam. When it is depressed it feeds the positive voltage from SE-2 through a 47K resistor to the grid of V3A by means of the CCW sensitivity control. This causes a heavy flow of plate current and actuates the plate relay. The action then proceeds as previously described. The location of this switch may be seen in upper lefthand corner of Fig. 1.

### Service Hints

1. Examination of the schematic of the control unit reveals that all four tubes are operated with *ac* rather than *dc* on the plates. The relays and solenoids are actuated by the current flow during the positive swing of plate voltage. For this reason, plate voltage should be measured with the meter set up for *ac* rather than the usual *dc* measurements.

2. There are three different control



units in production. They are identified by color dots marked near the "Auto-Manual" switch of the control chassis. The unit we have described is identified by two dots, one yellow and one blue. One of the other two units is identified by a single yellow dot, and the other by a single red dot. Circuit operation is similar for all units but there are slight differences which were made necessary by differing characteristics of the photocells. When replacing photocells therefore, make certain that the correct type is used. The photocells are not interchangeable for all three units.

3. Trouble shooting procedures are similar to those commonly used by servicemen. If any of the control circuits fail to operate, the trouble may be isolated to either the switching circuit or the control circuit by moving the switch contacts by hand. If the switching action takes place when this is done, the trouble must lie in the control circuit itself. If the switching action does not take place when this is done, then the control circuit is probably operating and the trouble will be found in the switching circuit.

## WORKBENCH

[from page 27]

also eliminated from the picture. L153 and L152, the 47.25 mc and 38 mc traps were not touched as the picture quality was now excellent. See Fig. 2.

The picture if carrier is 45.75 mc in this receiver. The sound if carrier is 41.25 mc. These two frequencies beat together and form the sound intercarrier frequency of 4.5 mc. The purpose of L151, (the misaligned trap) is to remove the 41.25 mc sound if carrier in order to keep it out of the video amplifiers. It is obvious therefore that because this trap was misaligned the 41.25 mc frequency was getting into the video amplifiers thus causing the sound bars.

### Dumont RA-105

The receiver was turned on and it was observed that this receiver had insufficient vertical sweep. Adjusting the vertical size control did not correct the problem. The 6SN7, V221 vertical output tube, and 1/2 6SN7, V220B, vertical generator were replaced but had no effect. See Fig. 3.

There are a certain number of components to check when up against a problem of this kind. Before making any checks however, it is important to check the vertical linearity of the raster by varying both the vertical size and vertical linearity controls. If the vertical linearity of the raster is satisfactory, then a number of components can be eliminated as possible causes of

from the VOICE OF AUTHORITY IN SWEEPS ...

# SPOT and FIX TV FAULTS FAST! FREE RAM BOOK SHOWS HOW!

Typical latest field-proven servicing data you'll find in your RAM book:



FAULT—Picture compression and stretching.

CAUSE—Capacitance value of boost capacitor (connected to linearity coil) too low



FAULT—Trapezoidal pattern.

CAUSE—Short in horizontal winding of Yoke.

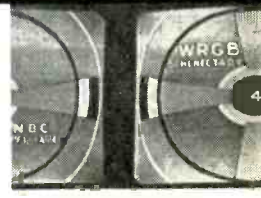

FAULT—Split picture.

CAUSE—Reversed AGC winding of H. Output Transformer; insufficient AGC voltage or reversed polarity.

For over 10 years, RAM has specialized and pioneered in sweeps exclusively. RAM designs them, makes them, counsels TV set manufacturers on them, field-services them, educates Servicemen on them — leads the industry.

No one but RAM can bring you such proven data — as shown here and in the RAM Manual. In manufacturing know-how and field experience, you can depend on RAM for . . .

### THE VOICE OF AUTHORITY IN SWEEPS

Send coupon today — get the BEST information from the FOREMOST manufacturer now!



**RAM ELECTRONICS SALES CO.** · Irvington, N. Y.  
Canadian Sales Division: Telequipment Mfg. Co., Ltd., Ontario  
Export Dept: Dage Corp., 219 E. 44 St., New York, N. Y.

for service and lab. work

## Heathkit PRINTED CIRCUIT OSCILLOSCOPE KIT FOR COLOR TV!

① Check the outstanding engineering design of this modern printed circuit Scope. Designed for color TV work, ideal for critical Laboratory applications. Frequency response essentially flat from 5 cycles to 5 Mc down only 1 1/2 db at 3.58 Mc (TV color burst sync frequency). Down only 5 db at 5 Mc. New sweep generator 20-500,000 cycles, 5 times the range usually offered. Will sync wave form display up to 5 Mc and better. Printed circuit boards stabilize performance specifications and cut assembly time in half. Formerly available only in costly Lab type Scope. Features horizontal trace expansion for observation of pulse detail — retrace blanking amplifier — voltage regulated power supply — 3 step frequency compensated vertical input — low capacity nylon bushings on panel terminals — plus a host of other fine features. Combines peak performance and fine engineering features with low kit cost!

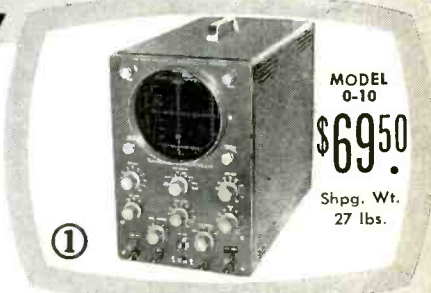

MODEL 0-10  
\$695.00  
Shpg. Wt. 27 lbs.

## Heathkit TV SWEEP GENERATOR KIT ELECTRONIC SWEEP SYSTEM

② A new Heathkit sweep generator covering all frequencies encountered in TV service work (color or monochrome). FM frequencies too! 4 Mc — 220 Mc on fundamentals, harmonics up to 880 Mc. Smoothly controllable all-electronic sweep system. Nothing mechanical to vibrate or wear out. Crystal controlled 4.5 Mc fixed marker and separate variable marker 19-60 Mc on fundamentals and 57-180 Mc on calibrated harmonics. Plug-in crystal included. Blanking and phasing controls — automatic constant amplitude output circuit — efficient attenuation — maximum RF output well over .1 volt — vastly improved linearity. Easily your best buy in sweep generators.



MODEL TS-4  
\$495.00  
Shpg. Wt. 16 lbs.

**Heath**  
COMPANY  
A SUBSIDIARY OF DAYSTROM, INC.  
BENTON HARBOR 29, MICH.

WRITE FOR FREE CATALOG  
... COMPLETE INFORMATION

AMERICAN TELEVISION & RADIO CO. ST. PAUL, MINN.

introduces the  
**new**

**ATR TV**

*Full Door Console  
Receiving Sets*

UNSURPASSED  
IN BEAUTY

UNEQUALLED  
IN PERFORMANCE

UNMATCHED IN  
QUALITY  
CONSTRUCTION

exclusive  
profitable  
dealer  
franchises  
now available



*designed  
with the  
Serviceman  
in mind  
... easy to  
get at*

WRITE TODAY FOR COLORFUL  
BROCHURE SHOWING THE  
NEW LINE OF ATR TV SETS

ALSO MANUFACTURERS OF DC-AC INVERTERS,  
"A" BATTERY ELIMINATORS, AUTO RADIO VIBRATORS

**ATR** AMERICAN TELEVISION & RADIO Co.  
*Quality Products Since 1931*  
SAINT PAUL 1, MINNESOTA-U. S. A.

trouble. In this case, the vertical linearity of the raster seemed to be correct. Thus, I repeat, all components that could cause defective vertical linearity were eliminated as a possible cause of this trouble.

Now the dropping resistor to the vertical output transformer T202 was checked. R315 and R316 checked correctly at 10K each. Next the load resistor of the vertical oscillator, R309, was resistance checked. It also checked correctly at 820K. The filter condenser C265A, 30  $\mu$ f, was next clipped out and replaced with a new one but it had no effect. At this point, the vertical output transformer, T202, was our next possibility. However, before replacing the vertical output transformer, a few voltage checks were made. The plate and cathode voltages of V221, the vertical output tube were checked at pins

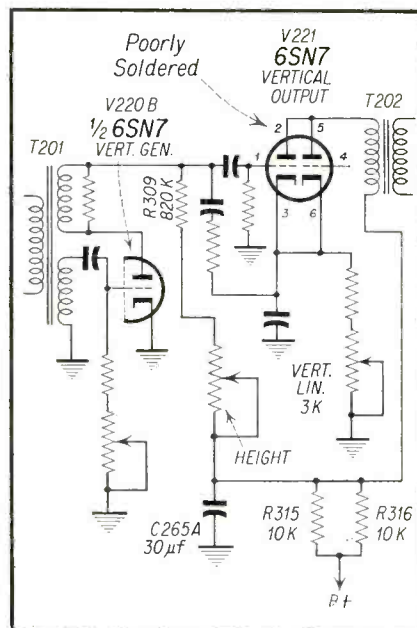

Fig. 3—Partial schematic of DuMont RA105

#5 and #3. While this was being done it was noticed that pin #2 which was tied directly to pin #5 was poorly soldered. Immediately a voltage check was made at pin #2. The meter read zero. The raster was observed after pin #2 was soldered. The vertical size was now more than enough. The vertical size control was now adjusted and the receiver functioned properly. (Naturally, with pin #2 disconnected only 1/2 of the 6SN7 is operating.)

## PROBEMETER

[from page 31]

oscillator or sweep signal, audio, radio oscillator and radio sound IF's, vertical

ask the  
"Man-on-the-Roof"  
why he prefers

*South River*

TWO  
TO A  
SET



## RATCHET TYPE CHIMNEY MOUNT

Model RT (Galv. Banding)

Model RT-ST (Stainless Banding)

FASTEST, SIMPLEST, MOST  
CONVENIENT EVER MANUFACTURED

Mounts in 2 simple steps. Completely factory assembled with no eyebolts, banding clips, nuts etc., to handle. Furnished with flat-lay, non coiling banding, heavy gauge embossed, welded steel construction. Forged, heat treated Alum. ratchets.

WRITE FOR OUR LATEST CATALOG

**SOUTH RIVER**  
METAL PRODUCTS CO., INC.  
South River, New Jersey

pioneer & outstanding  
producer of  
finest line  
of antenna  
mounts

don't  
just say  
capacitors

Ask For Sprague By Catalog Number

Know what you're getting . . .  
get exactly what you want.  
Don't be vague . . . insist on  
Sprague. Use complete  
radio-TV service catalog  
C-610. Write Sprague Products  
Company, 71 Marshall Street,  
North Adams, Mass.

**SPRAGUE**®

WORLD'S LARGEST  
CAPACITOR MANUFACTURER

help your  
HEART FUND  
help your HEART





Problem:

2 TV Sets  
1 Antenna

Answer:



## 2-SET COUPLER

Model TV-42  
Approved for Color TV  
UHF, VHF and FM



Cost: ONLY \$2<sup>95</sup> LIST

### Features:

- Matched resistive circuit
- Flat response — 0 to 900 megacycles
- 12db inter-set isolation
- Easy to install
- Couples 2 TV sets without ghost or smear

### Application:

In class A signal areas the B-T 2-Set Coupler provides the ideal low cost solution to the problem of operating two receivers from one antenna. There are other applications. For example, the TV-42 can couple a TV set and FM receiver to one antenna—or it can be used, in reverse, to couple or mix 2 antennas to one receiver.

Write for FREE BOOKLET — "TV for 2 or 3... or More"  
Covers all types of Multiple TV Systems

Sold by Radio-TV Parts Distributors and Jobbers

**BLONDER-TONGUE LABORATORIES, INC.**

Dept. LA-7 Westfield, New Jersey



Manufacturers of TV Cameras,  
TV Amplifiers, Boosters,  
UHF Converters, TV Accessories  
and Originators of the Masterline  
and 'Add-A-Unit' Master TV Systems.

oscillator, arcing, noise pulses and sync pulses. Low frequencies give little or no indication when the pointer knob is in the extreme clockwise position (VIDEO, OSC, IF, RF) (high frequency position).

Audio is generally received in the 3rd position (VIDEO, AUDIO). For low frequencies, the knob is turned slightly for maximum indication.

Strong high frequency signals can be received when the indicator knob is not at the high frequency position. This depends upon the strength of the signal and whether a direct contact test is made. Thus, strong high frequency signals can be attenuated. This is usually necessary at the latter if or video stages.

To establish that video is present at the socket of the picture tube (grid or cathode pin) an approximately equal reading must be obtained on both the high and low frequency positions of the meter. Equal proportions of high and low frequencies indicate good video. If the signal at the video output stages indicates only on the high or low frequency position, then the indicated signal is not video. When making this test care must be taken however that the receiver selector is on channel, that the fine tuning oscillator is tuned to maximum frequency response, and that the receiver antenna is turned in the proper direction. Generally, when high frequency only is indicated at the cathode or grid of the picture tube, the pix if signal has not been detected (at the detector). The indicated high frequency would be caused by the pix if signal, beats or oscillations.

Predominance of low frequency response can be caused by open peaking coils, mis-alignment, oscillations, improper or defective circuits, etc.

Many TV sets (especially those with unshielded horizontal and high voltage power supplies) are saturated with the 15 kc horizontal sweep signal (chassis and wiring). Thus it is possible, with the probe meter to get a horizontal reading at any point on the chassis. Any unrelated circuit, wiring, or any point that will afford a path or act as an antenna for the signal. To determine if the offending signal is the horizontal sweep signal, simply turn control to the high frequency position (OSC, IF, RF), or to verify, remove horizontal oscillator or output tube. (Note: When the control is in the high frequency position it is extremely difficult to get a horizontal or low frequency reading.)

When checking B plus voltage (use plug-in ground wire) the knob is turned to the extreme counter-clockwise position until the switch is activated. The meter will indicate B plus or ac when the knob is in the attenuate position. This reading is not to be con-

# Merit

FIRST IN EXACT REPLACEMENT.

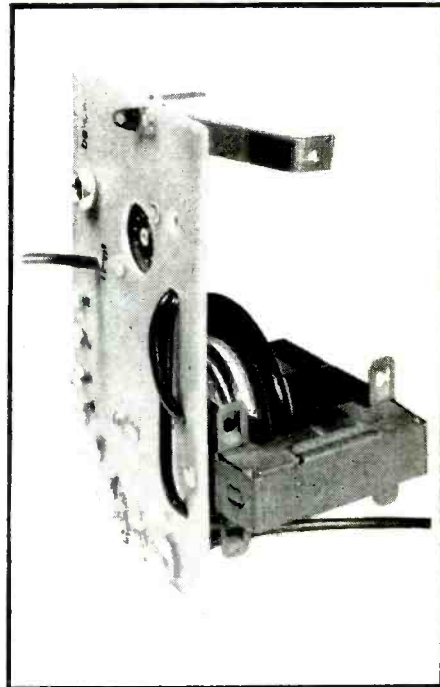

**HVO-50 FOR EXACT REPLACEMENT** in over 75 TRAV-LER models and chassis. Another in the complete Merit line of exact and universal transformers, yokes and coils. Merit is the only manufacturer of transformers, yokes and coils who has complete production facilities for all parts sold under their brand name.

# Merit

MERIT COIL & TRANSFORMER COMPANY  
4427 N. CLARK ST., CHICAGO 40, ILL.

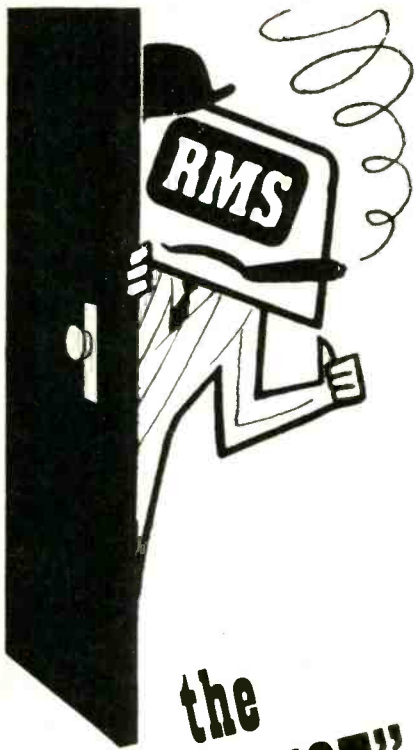

the  
"BIG SHOT"  
is coming

RADIO MERCHANDISE SALES • N. Y. 62, N. Y.



"I had a terrible night last night—dreamt we were out of JENSEN NEEDLES."

fused with the signal reading when testing under the chassis. Excessive *ac* can usually be detected in the B plus circuit or supply. A .1 $\mu$ f condenser is connected in series with the meter to block out the *dc* voltage.

The effect of *age* must not be forgotten when attempting to measure gain. AGC can nullify the gain at the 1st stages. To disable the *age* circuit, a tube is removed in the latter stage (2nd or 3rd *if*), or, if available, the *age* control is turned off.

#### Color TV

The Probe Meter is especially useful for troubleshooting color TV circuits. Here, proper balance and proportion of signal is important. Oscillators can be tested immediately. Tracing and comparing signals can be done with comparative ease. A test to determine the amount of signal entering the grid of each of the three guns can be done immediately after the back is removed.

#### COLOR

[from page 26]

sync pulses. Also connected in the output of the sync separator is a sync delay network which provides the delay shown in (C). Thus, the retrace pulses developed in the horizontal output transformer have this same delay.

Returning now to the chroma signal we notice that the output of the chroma amplifier (E) is in the same time phase as waveforms (A) and (B). For this reason the time of the burst signal as shown in (E) now coincides with the delayed retrace pulses shown in (C). As a result the color burst signal coincides with the delayed sync pulses, and the output of the Burst Gate tube contains only the color burst signals as shown in (D).

#### ASSOCIATION NEWS

[from page 16]

logically believe that since the Salinas station advertises in this area, reception must be good. But Association service shop owners, after several months of battling to bring in a good picture with Channel 8's weak signal in many Valley areas, are forced to advise set owners that the KSBW-TV signal locally is highly reluctant.

#### Associated Radio-TV Servicemen of N. Y.

ARTSNY reports that it has reopened its Manhattan Clinic. The new

## HAVE YOU SEEN VOLTA-CHEK PICTURE TUBE VOLTAGE TESTER

SIMULTANEOUSLY TESTS  
ALL VOLTAGES  
OF THE CATHODE RAY TUBE  
ELIMINATES GUESS WORK

SMALL  
COMPACT  
ELECTRONICALLY  
ACCURATE  
EASY-TO-USE



SEE YOUR DISTRIBUTOR or WRITE  
ELECTRONIC

### TEST

INSTRUMENT  
CORPORATION

13224 LIVERNOIS AVE., DETROIT, MICH.

VOLTA-CHEK MADE BY MAKERS OF THE  
NATIONALLY ACCEPTED VITAMETER

#### NEW folding platform attachment fits all YEATS dollies

carries TV models & chassis  
ends back breaking  
lifting & lugging!



Folds up when not in use!

Attached instantly, this ingenious new aid to TV and radio repairmen ends second story service problems when removing TV table models or chassis. With this new attachment, YEATS dolly users can use the dolly for chassis and table models as well as consoles . . . enjoy all the

famous YEATS handling conveniences: 30 second strap ratchet fastening, caterpillar step glide and on-a-dime turning. Folding Platform is 13 1/2" x 24", priced at \$9.95. Call your YEATS dealer today!

SEND postcard  
for full information  
on our complete  
line TODAY!

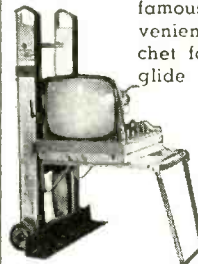

## YEATS

appliance  
dolly sales co.

2133 N. 12th St.

Milwaukee 5, Wis.



## SECOND ONLY!

to the Volt-Ohm Meter as a handy general T.V. tester! (It's the primary RF signal that counts!)

a professional instrument designed for testing a T.V. ABOVE and BELOW chassis!

**THE VIDEO PROBE METER!**

Saves **TWO HOURS PER DAY** when used in shop for under chassis work.

\$31.50 Model VI



With the attachable pick-up loop, (where sufficient signal is available) the Probe Meter can detect and indicate radiation of signal thru I.F. and video amp tubes. (Simply slide loop over tube being tested.) Where internally shielded tubes are encountered, remove tube and insert probe tip into grid pin of socket. Indicates gain per stage.



Can accurately trace and indicate the following T.V. circuits.—(from tuner to pix tube) R.F., I.F., Det., Video, Sync, local osc., Hz. osc., Hz. Drive, audio output, sound I.F. (Signal tracing radios).

**EXCELLENT FOR TRACING AND COMPARING COLOR T.V. CIRCUITS.**

**ADDITIONAL FEATURES**

Voltmeter, 0-500 V. D.C., 20,000 Ohms/volt

Fully Guaranteed

If your dealer cannot supply you, order direct full purchase price refunded if not satisfied. DEALERS, REPS. & DISTRIBUTORS WILL RECEIVE IMMEDIATE ATTENTION.

Research Inventions & Manufacturing Co.  
617 F St., N. W., Washington 1, D. C.

address is 401 East 74th Street. The recent initial issue of the ARTSNY "Newsletter" is excellently prepared. Its "newsy" and intimate style should make all future issues something to be looked forward to for all radio and TV servicemen in the New York Metropolitan area.

### Philadelphia Radio Servicemen's Assoc., Inc.

P.R.S.M.A. presented Gordon Jolly of Westinghouse at the Franklin Institute on Tuesday, December 6, 1955. Mr. Jolly spoke on printed circuits and how to repair them.

### Radio & TV Servicemen's Ass'n of Pittsburgh, Pa., Inc.

C. R. Rogers of Sylvania Electric Products, Inc., presented a lecture on the current Sylvania TV chassis and means of streamlining service procedures on November 8, 1955.

### San Francisco TV Service Guild

One of the guild shoppers purchased a package of tubes in one of the local drug stores equipped with a "Test-It-Yourself" tube checker. The tubes bore absolutely no brand or date markings except one which was an N. U. 6AL5. Furthermore, they were wrapped in boxes of green and black color bearing the name National Electronics. What a "racket" this could turn out to be!

## NEW FM TUNERS

[from page 12]

circuit. A low impedance output is obtained from the cathode follower to provide the audio voltage to the audio output amplifier.

### Audio Output Ratings and Frequency Response

The output audio level is often provided among tuners characteristics and can be stated in terms of voltage, distortion percentage and noise level of the system. An audio output rating might be given for a particular tuner as .5 volts (rms) with 1% distortion and a noise level 60 db below the output audio level.

The frequency response at the output of the tuner is also a very important aspect in high fidelity reproduction. A frequency range of the audio signals from 30 to 15,000 cps is to be expected and generally the response is much better than this being in the order of 20 to 20,000 cps.

Following articles will delve into these stages found in FM tuners, discussing and analyzing their various circuits.

## SHOOT TV TROUBLE FAST!

With H. G. Cisin's Copyrighted RAPID "TV TROUBLE SHOOTING METHOD"

Without experience or knowledge, this guaranteed new method of servicing TV sets enables you to DIAGNOSE TV troubles as rapidly as an expert. **NO THEORY—NO MATH**—you can locate all faults in record-breaking time, regardless of make or model. "TV TROUBLE SHOOTING METHOD" is the most valuable aid to TV servicing ever written. Be a TV Trouble Diagnostician. Increase your present earnings. Open your own Profitable Business or get a high-paying skilled job.

It's all in this book . . .

**Nothing more to Pay—Nothing else to Buy**

Alphabetically listed there are 85 picture troubles, over 58 raster and 17 sound troubles and by this unique copyrighted method you know EXACTLY WHERE the trouble is; plus step-by-step instructions, including 69 RAPID CHECKS, enabling you to find the faulty part.

**13 IMPORTANT PRELIMINARY CHECKS NEED NO INSTRUMENTS!** Of the 69 Rapid Checks, **OVER 65 ALSO REQUIRE NO INSTRUMENTS!** Rapid checks include emergency checks for distorted pictures, defective tubes including PIX tube, plus 57 others. **ALL EXPLAINED IN SIMPLE LANGUAGE. PERFORMED WITHOUT INSTRUMENTS. MANY CHECKS USE THE PICTURE TUBE AS A GUIDE.**

H. G. Cisin, the author, is the inventor of the AC/DC midget radio. He licenses RCA, AT&T, etc. He has also trained thousands of technicians now owning their own prosperous TV service organizations or holding highly paid TV positions. His years of experience are embodied in this remarkable new TV TROUBLE SHOOTING METHOD. **Guaranteed, Money Back in 5 Days if Not Satisfied!**

**ABSOLUTELY FREE** with each order: H. G. Cisin's newest book "TV & RADIO TUBE SUBSTITUTION GUIDE." Gives direct replacements of set and picture tubes. Most valuable servicing aid! **ACT NOW—get both books postpaid at cost of only one!**

\$1 Post-paid

**RUSH COUPON NOW!**

H. G. CISIN, CONSULTING ENGINEER,  
Amagansett, N. Y. (Dept. D-1)

Enclosed find \$1. Rush both books.

Name \_\_\_\_\_  
Address \_\_\_\_\_  
City \_\_\_\_\_ Zone \_\_\_\_\_ State \_\_\_\_\_

## WRITE FOR THIS



## DEALER SALES KIT MAKE BIG HI-FI PROFITS

Sell the finest HI-FI Units for custom building or in BEAUTIFUL CABINETS... Sell **BELOW REGULAR WHOLESALE PRICES** with full dealer mark-up and with price protection.

TRANSVISION Hi-Fi Equipment is **SOLD THRU SELECTED DISTRIBUTORS**

TRANSVISION, INC., NEW ROCHELLE, N. Y.  
In Canada: 1338 Queen St. W., Toronto 3, Ont.

TRANSVISION, INC., New Rochelle, N. Y. SD-1  
Rush FREE Dealer SALES KIT on HI-FI and name of nearest distributor.

Name \_\_\_\_\_  
Address \_\_\_\_\_  
City \_\_\_\_\_ State \_\_\_\_\_

**DON'T JUST SAY CAPACITORS**

Ask For Sprague By Catalog Number

Know what you're getting . . . get exactly what you want. Don't be vague . . . insist on Sprague. Use complete radio-TV service catalog C-610. Write Sprague Products Company, 71 Marshall Street, North Adams, Mass.

**SPRAGUE**

WORLD'S LARGEST CAPACITOR MANUFACTURER

**DON'T JUST SAY CAPACITORS**

Join The Red Cross

**New! COLOR  
& BLACK & WHITE  
LAB & TV SERVICE  
5" SCOPE**



**KIT  
\$79.95  
Factory  
Wired  
\$129.50**

#460

- Flat from DC to 4.5 mc to reproduce 3.58 mc sync burst and oscillator signals in color TV sets.
- V amplifier direct-coupled and push-pull thru-out; gradual roll-off beyond 4.5 mc, useful at 10 mc.
- High V sensitivity: 25 mv/in.
- Choice of direct coupling (DC) or capacitive coupling (AC).
- 4-step frequency-compensated attenuator in both AC and DC positions.
- Built-in calibrator permits peak-to-peak voltage measurement.
- Automatically syncs anything visible on the screen.
- Pre-set TV V & H sweep positions. (30 cps & 7875 cps).
- Edge-lit lucite engraved graph screen with dimmer control; filter; standard bezel fits standard photographic equipment.
- 5U1P CRT.

Prices 5% Higher on West Coast  
Write for Name of Distributor  
& FREE New 1956 CATALOG D-1

84 Withers St. • Bklyn 11, N. Y.  
NOW IN STOCK AT YOUR NEIGHBORHOOD  
DISTRIBUTOR—ORDER NOW!

©56

**Advertising Index**

Allied Radio Corp.	48
American Scientific Dev. Co.	40
American Television & Radio Co.	44
B & K Manufacturing Co.	22
Blonder-Tongue Laboratories, Inc.	45
Bussmann Manufacturing Co.	5
CBS-Hytron	15
Centralab	41
Chicago Standard Transformer Corp.	48
Cisin, H. G.	47
Cornell-Dubilier Elec. Corp.	1
Eico	48
Electronic Test Instrument Corp.	46
Federated Television Mart, Inc.	48
General Cement Mfg. Co.	13
Heath Company	43
Hickok Elec. Instrument Co.	39
International Resistance Co.	Cover 2
Jensen Industries	46
JFD Manufacturing Co., Inc.	9
Merit Coil & Transformer Co.	45
Moss Electronic Dist. Co., Inc.	17
Oxford Electric Corp.	42
Pyramid Electric Company	Cover 3
Radiart Corporation	1
Radio Merchandise Sales	46
Ram Electronic Sales Co.	43
Raytheon Manufacturing Co.	2
RCA Tube Dept.	Cover 4
Research Inventions & Mfg. Co.	47
Rider, John F., Publisher	16
Sams, Howard W. & Co.	8
Simpson Electric Company	37
South River Metal Prods. Co.	44
Sprague Products Company	44, 47, 48
Tarzian, Sarkes, Inc.	38
TeleTest Instrument Corp.	40
Transvision, Inc.	47
Tung-Sol Electric, Inc.	6, 7
Walsco Electronics Corp.	23
Yeats Appl. Dolly Sales Co.	46

**for all your  
Exact Replacement  
TV TRANSFORMERS**

**Specify  
Stancor**

**FREE**

STANCOR TV Transformer Replacement Guide listing over 8000 models and chassis of 117 manufacturers... also STANCOR Auto Radio Replacement Guide with replacement data on over 540 auto radios of 40 manufacturers. Available from your distributor or by writing Chicago Standard.



**CHICAGO STANDARD  
TRANSFORMER CORPORATION**

3586 Elston Avenue • Chicago 18, Illinois

Only TOP-QUALITY brands of  
**STANDARD  
BRAND TUBES**

NEW... FIRST QUALITY. Each tube carries a ONE YEAR GUARANTEE. Latest datings, no rejects, no rebrands or rewashed bargains.

Imported from England  
**SPECIAL 6V6G . . . 29¢**  
Low internal noise. Rugged construction

**WHILE THEY LAST!**

6AG7	39¢	6SK7GT	45¢
6AQ5	49	6SK7	44
6AS7	89	6YG6	29
6AK5	49	12AT7	49
6H6	17	12AX7	49
6J5GT	45	12BA7	49
6K7GT	16	826	49

**SPECIAL! THIS MONTH ONLY**

0Z4	47¢	5U4GB	63¢	35B5	49¢
1R5	59	6U8	72	12BH7	72
6AG5	75	7N7	62	12SN7	49
6AT6	49	12AY7	98	9002	49
6AC7	59	12AU7	72	867W	89
5V4	49	12AV6	49	12SH7	59
6SH7	39	12BE6	59	25L6	59
6SN7	66	12BA6	59	35L6	59
1T4	59	12CU6	1.10	5V6	69
1U4	59	6SA7	59	1V2	49

**GOV'T SURPLUS 2X2. . . . .59¢**

No Order Too Small. These tubes shipped within 24 hours of receipt of order. 25% deposit required with order. F.O.B. Brooklyn.

**FEDERATED TELEVISION  
MART, INCORPORATED**

513 Rogers Ave., Dept. RS, Brooklyn 25, N. Y.

**Don't just say  
CAPACITORS**

**Ask For Sprague By  
Catalog Number**

Know what you're getting . . . get exactly what you want. Don't be vague . . . insist on Sprague. Use complete radio-TV service catalog C-610. Write Sprague Products Company, 71 Marshall Street, North Adams, Massachusetts.

**SPRAGUE**

WORLD'S LARGEST  
CAPACITOR MANUFACTURER



save up to **70%**  
**BUILD YOUR OWN**

**knight-kit  
CAPACITOR  
CHECKER KIT**

Save time & trouble

Only  
**\$11.65**

Tests capacitors while they are still wired in the circuit! Just press a button and the "magic eye" instantly shows opens and shorts. Checks by-pass, blocking, coupling and filter condensers from 20 mmf to 2000 mfd, even when the capacitor under test is wired with a resistance as low as 60 ohms. Capacitors between .1 mfd and 2000 mfd may be tested even when in parallel with resistance as low as 2 ohms. Housed in the professionally styled Knight-Kit case. Complete kit, ready for easy assembly. Shpg. wt., 5 lbs. Model F-119. Capacitor Checker Kit. Buy Direct and Save. Only **\$11.65**

**FREE**

**Send for our 324-page catalog**



Lists dozens of other low cost quality Knight-Kit test instruments, plus the world's largest selections of parts and equipment for the Service Technician. Write for FREE copy.

**ALLIED RADIO**

ALLIED RADIO, Dept. 26-A-6,  
100 N. Western Ave., Chicago 80, Ill.

- Send Kit described above. \$ . . . . . encl.
- Send Free 324-Page ALLIED Catalog.

Name . . . . .  
Address . . . . .









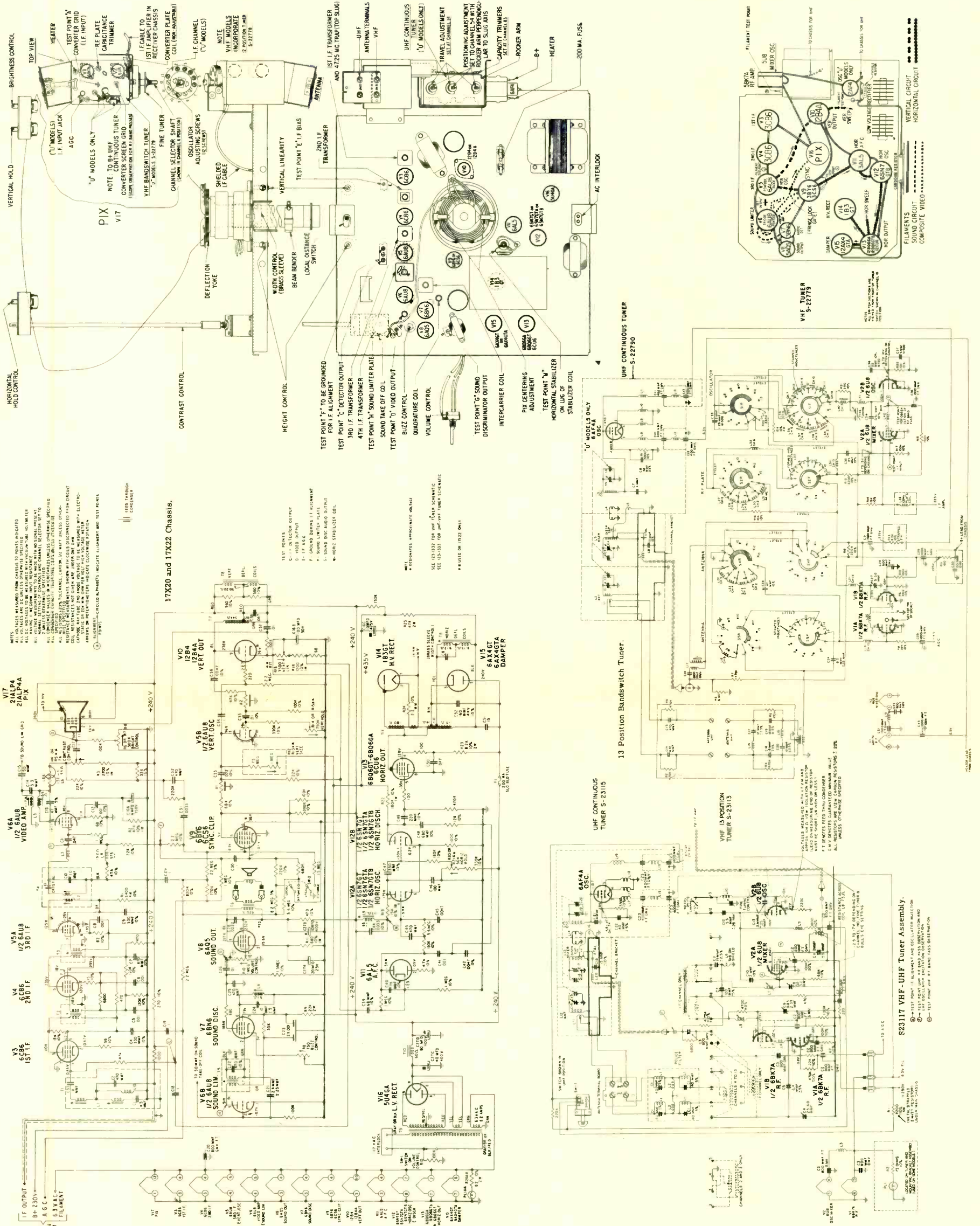







where do you find

**PYRAMID**

CAPACITORS AND SELENIUM RECTIFIERS

In the electronic products of all these leading brand manufacturers—where their presence testifies to PYRAMID'S high standards of quality and service.

**Admiral** **Magnavox**



**Motorola**

**CROSLEY**

*Packard-Bell*

**DUMONT**

**RAYTHEON**

*Emerson*



**SYLVANIA**

**hallicrafters**

**Westinghouse**

**Hoffman**

**ZENITH**

AND you find PYRAMID as a participant in Howard Sams PHOTOFACT—the bible of radio-television-sound field servicing—which guarantees accurate replacement with PYRAMID parts and testifies to the immediate availability of PYRAMID Capacitors and rectifiers throughout the country.

*Howard Sams*

**RF**  
PHOTOFACT



**PYRAMID ELECTRIC CO.**  
North Bergen, New Jersey

THE BIG NAME IN CAPACITORS AND SELENIUM RECTIFIERS TODAY...

HANDLE YOUR REPLACEMENTS FOR OVER 110 TYPES OF PICTURE  
TUBES WITH JUST 25 TYPES...TYPES IN THE GREAT NEW LINE OF

# RCA Silverama

**SUPER-ALUMINIZED PICTURE TUBES**

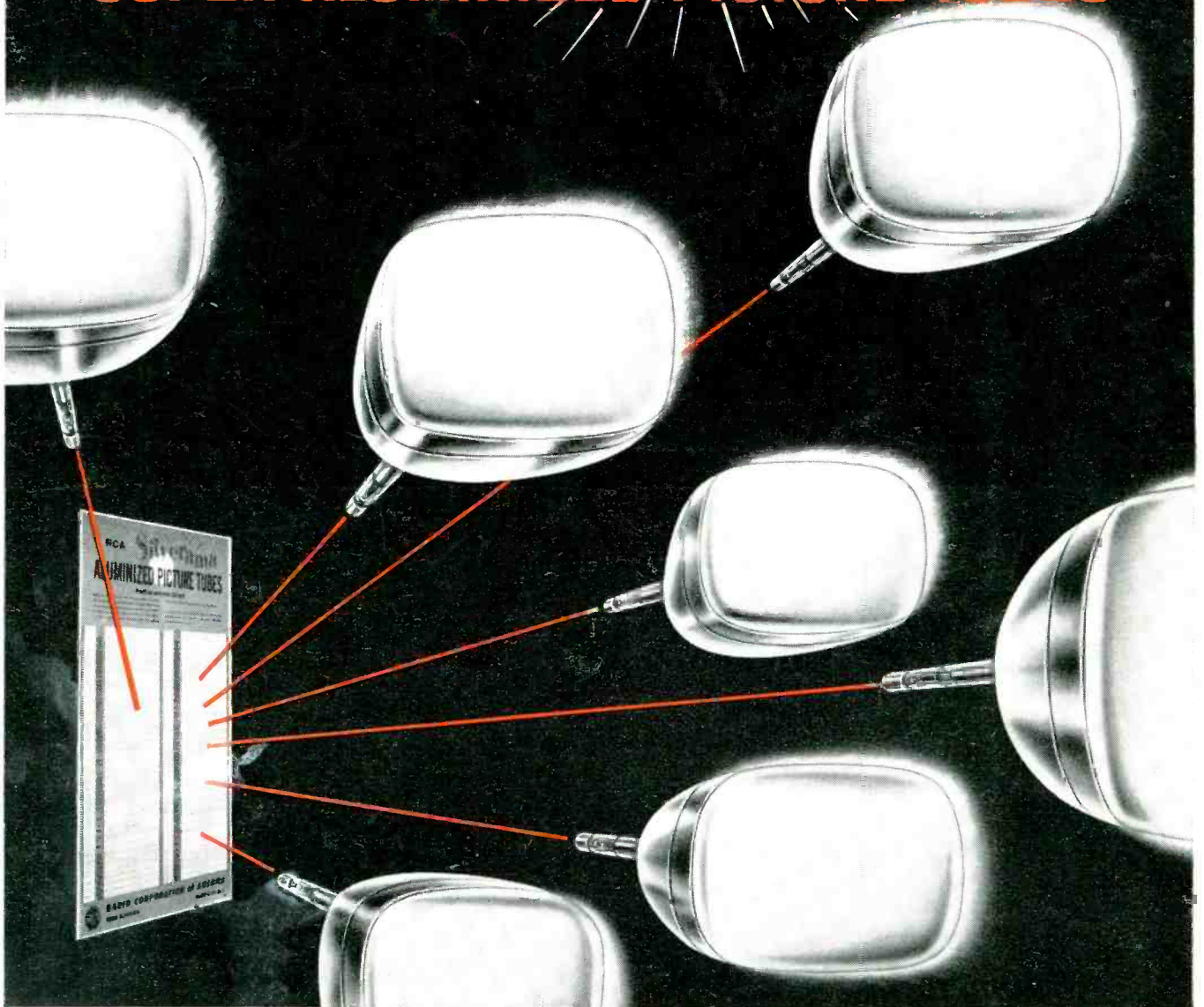

**25 types—8 sizes—10" to 27"**

RCA's new Silverama Replacement Chart—yours, for the asking—tells you at a glance what RCA Silverama Picture Tubes to use when making replacements, no matter what model or make set you're servicing. And every Silverama insures a brighter, clearer, sharper picture with greater contrast. Just wait 'til your customers view the new life you've given to their sets with Silverama Aluminized Picture Tubes! See your local RCA Distributor for full details, or write to Commercial Engineering, RCA Tube Division, Harrison, N. J., for form 4F909.

*You profit while you please—with RCA Silverama.*



**PICTURE TUBES**

RADIO CORPORATION OF AMERICA • HARRISON, N. J.